



Arquitectos & Asociados

FileniFileniDesign®



Unique
Rosbaco
Collection®

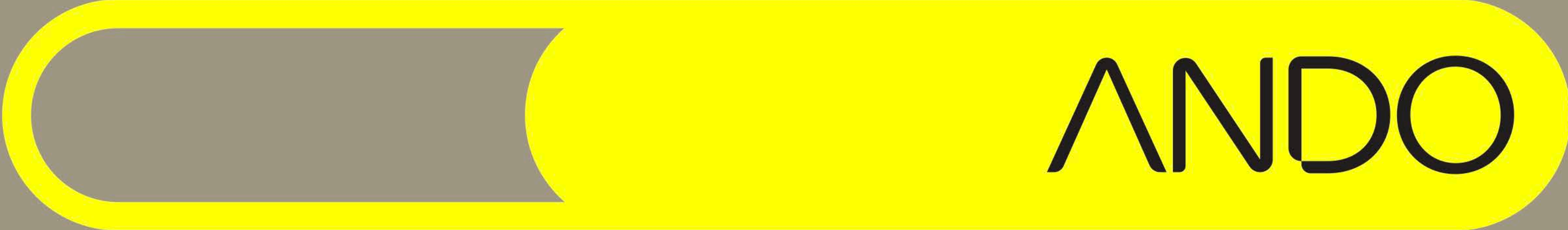

ANDO + LUZ



Unique
Rosbaco
Collection®

ANDO + DISEÑO



Unique
Rosbaco
Collection®

ANDO + RELAX

Gral. Paz/ Acc. Norte

Belgrano R



Villa Urquiza

Cullen
Franklin D. Roosevelt
Av. Monroe
Blanco Encalada
Av. Olazábal
Mendoza
Av. de los Constituyentes

Andonaegui 2129



ANDO + UBICACIÓN

Av. Triunvirato
Avalos
Bauness
Bucarelli
Andonaegui

Palermo

Chacarita

Parque Chas

Juramento

Echeverría

Barzana

Unique
Rosbaco
Collection®

ANDO + AUTÉNTICO

Unique
Rosbaco
Collection®

ANDO + AIRE



Unique
Rosbaco
Collection®

ANDO + SOFISTICADO



ANDO + ESPACIO





Unique
Rosbaco
Collection®

ANDO + NOBLE



ANDO + ORIGINAL

ANDO + DETALLES



Unique
Rosbaco
Collection®

ANDO + SKY FOREST





BMA

El estudio Bodas Miani Anger & asociados es actualmente uno de los más importantes de Argentina.

Su trayectoria habla por sí sola, habiendo diseñado obras emblemáticas en grandes ciudades del mundo.

www.bmaestudio.co.ar
ig: @bmaarqs

FileniFileniDesign®

Desde hace más de 30 años el estudio Fileni Fileni se ha dedicado al diseño con una particular mirada.

Su claridad y síntesis para desarrollar ideas han colocado al estudio en unos de los más destacados de la región.

www.filenifileni.com
ig: @filenifilenidesign

Unique
Rosbaco
Collection®

ANDO + PRESTIGIO

ANDO + CÓMODO



Unique
Collection
Rosbaco®

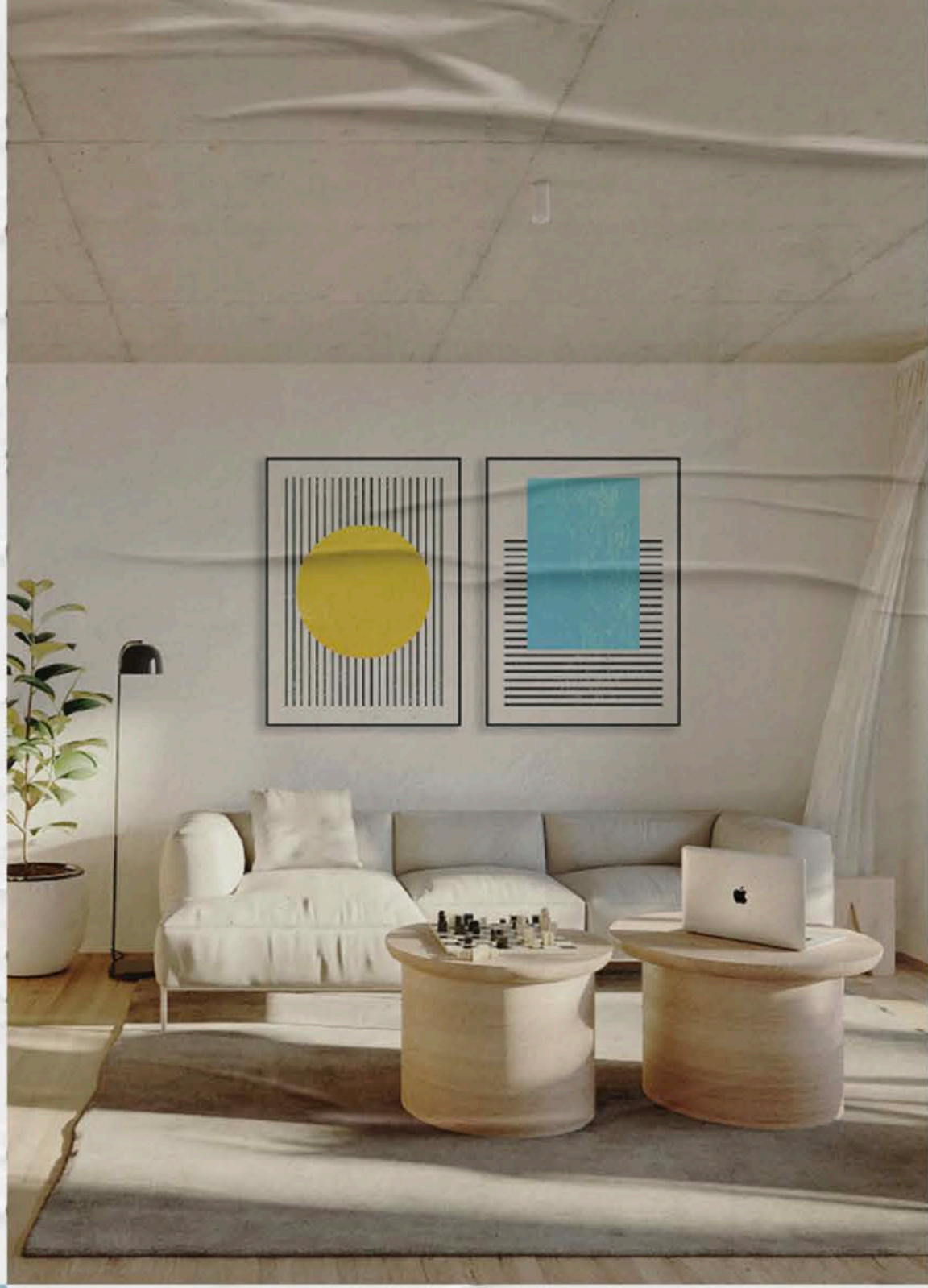
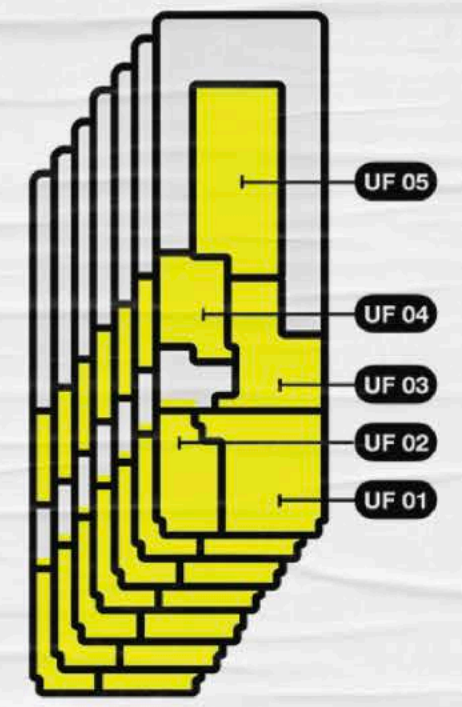

Unique
Collection
Rosbaco®

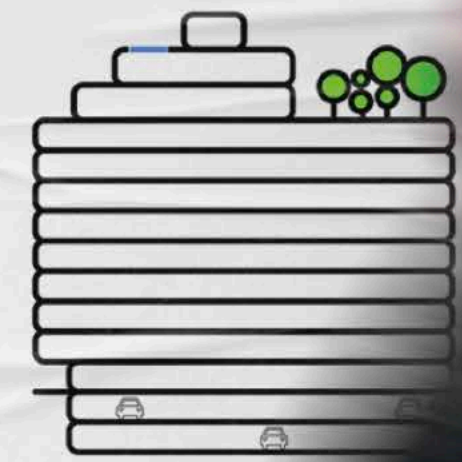

ANDO + IDEAS

Unique
Rosbaco
Collection®



Unique
Collection
Rosbaco®

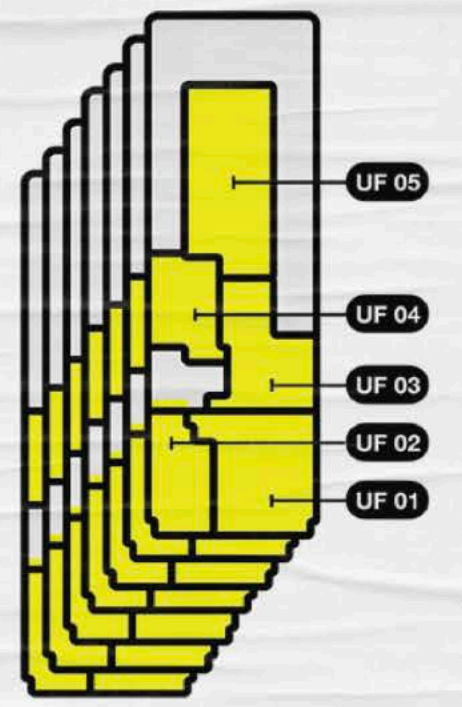

Unique
Collection
Rosbaco®

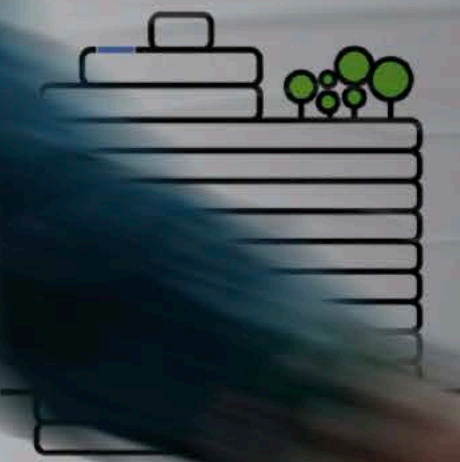

Unique
Rosbaco
Collection®

ANDO + AMIGOS



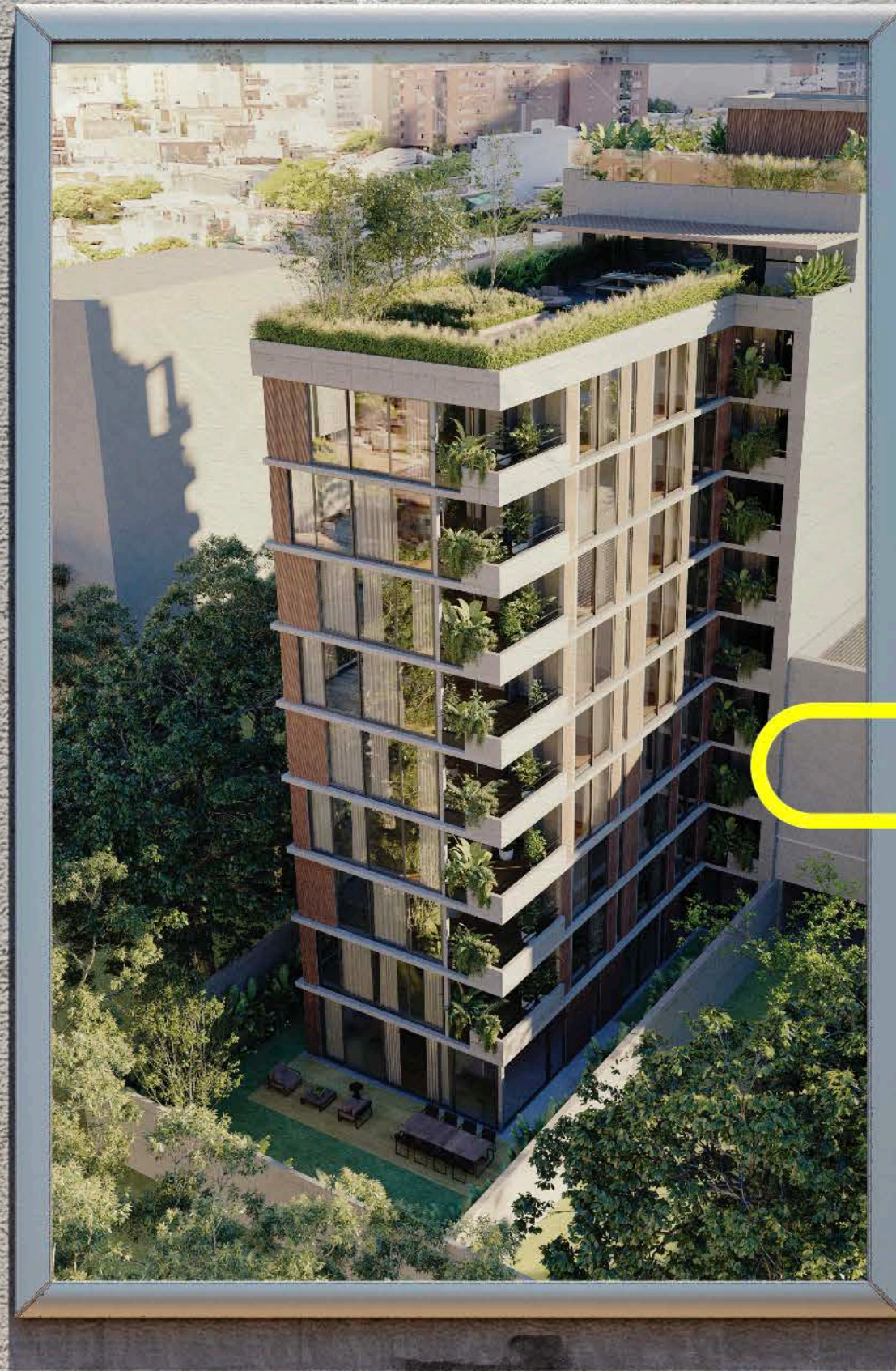

ANDO + VISTAS



ANDO

+ CALIDAD

Unique
Rosbaco
Collection®



ANDO + ENCUENTROS

Unique
Rosbaco
Collection®

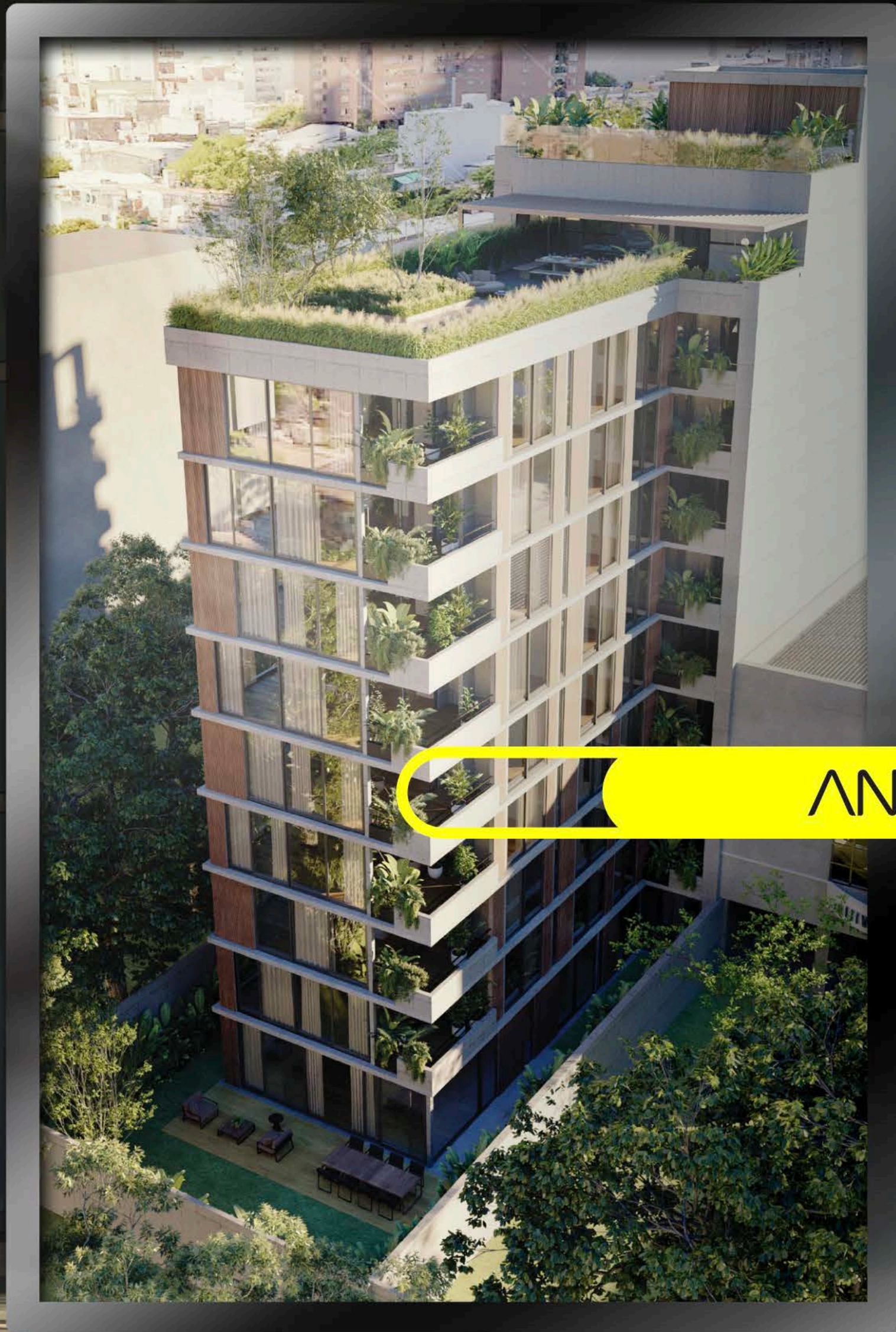

ANDO + SUSTENTABLE

A

41 Departamentos

15 unidades de
2 ambientes

16 unidades de
3 ambientes

10 unidades de
4 ambientes

N

1 Local comercial

11 pisos

Planta baja + 10 plantas

D

2 subsuelos

28 Cocheras fijas
Bike parking

O

**Piscina
SUM**

**Workspace
Sky Forest
Laundry**

Vista

Esquema general

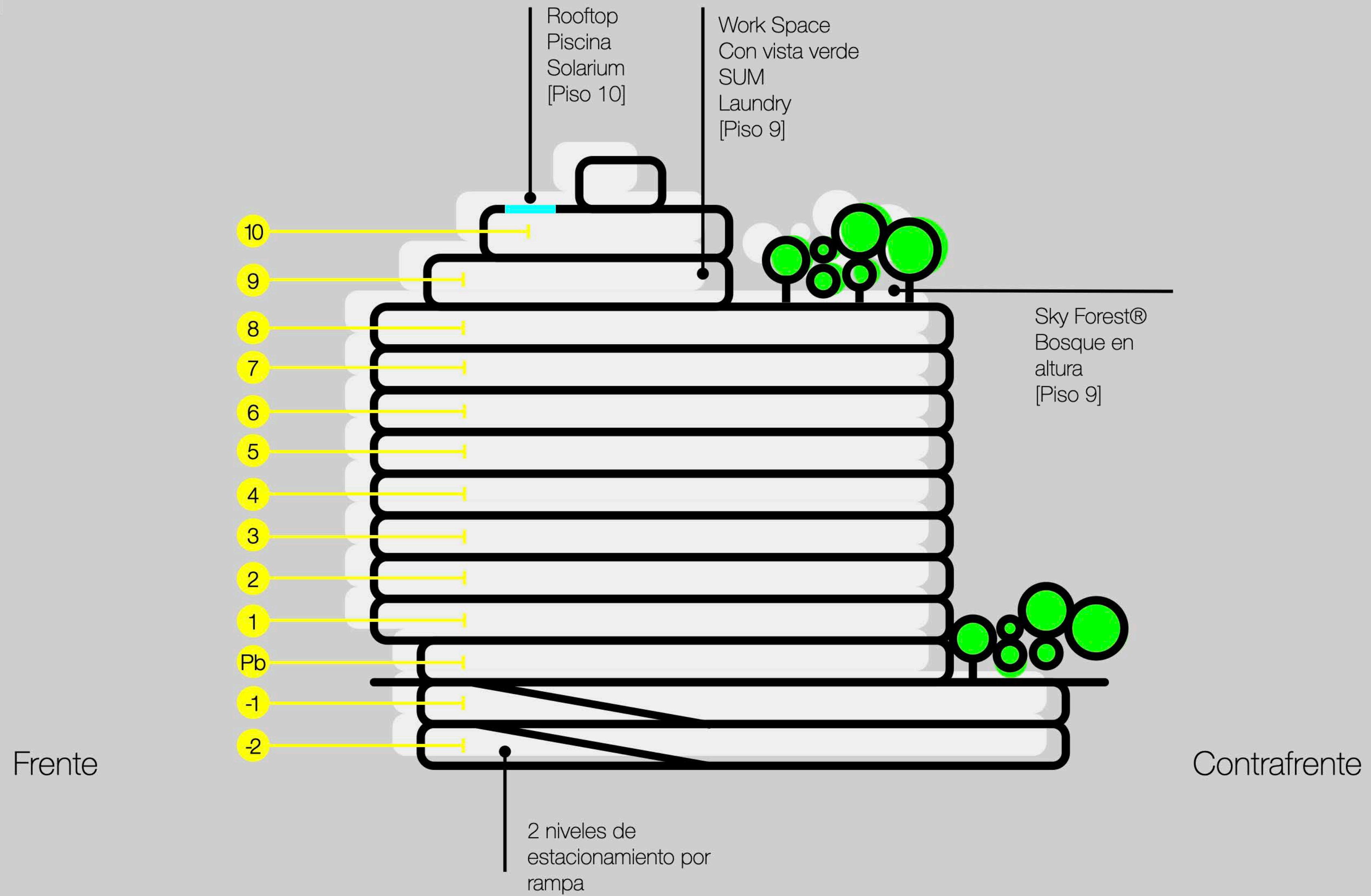

Distribución de plantas

Unique
Rosbaco
Collection®

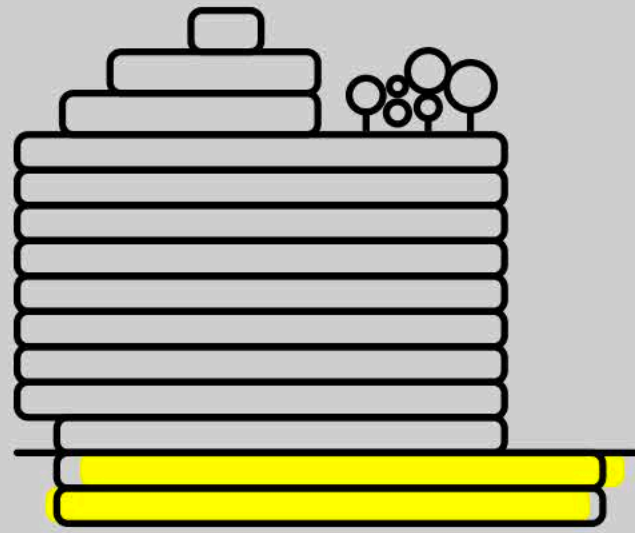

Subsuelos

-1
14 cocheras
Fijas por
Rampa

-2
14 cocheras
Fijas por
Rampa

Bike parking

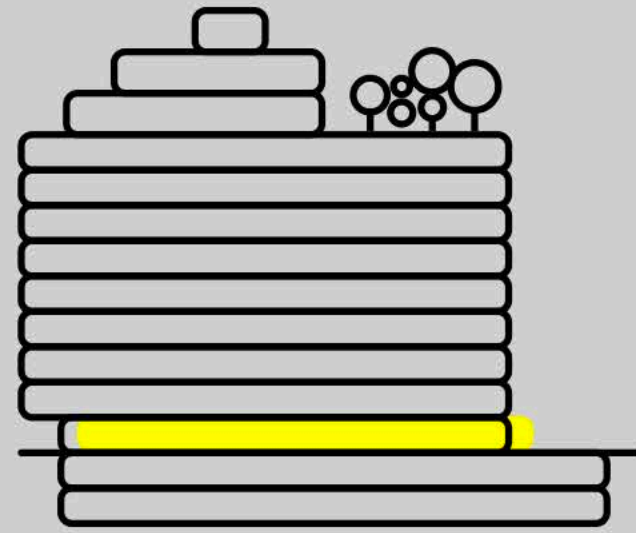

Planta Baja

UF 01
Casa
4 Ambientes
350 m²

Local
Comercial

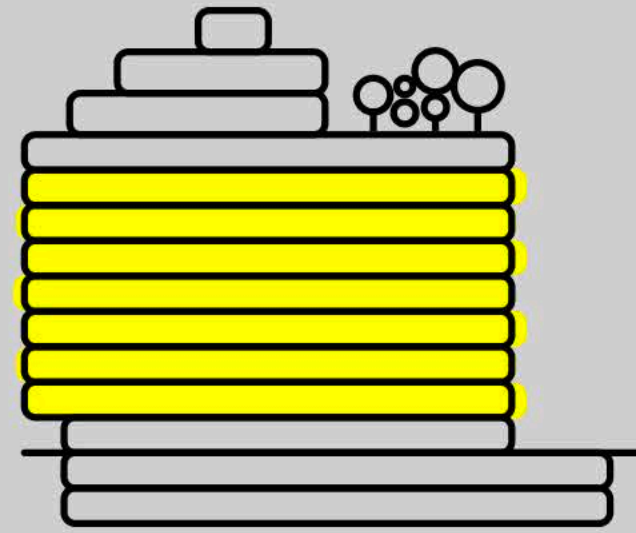

Plantas del 1° al 7°

UF 01/
2 Ambientes
65 m²

UF 02/
3 Ambientes
92 m²

UF 03/
3 Ambientes
84 m²

UF 04/
2 Ambientes
61 m²

UF 05/
4 Ambientes
131 m²

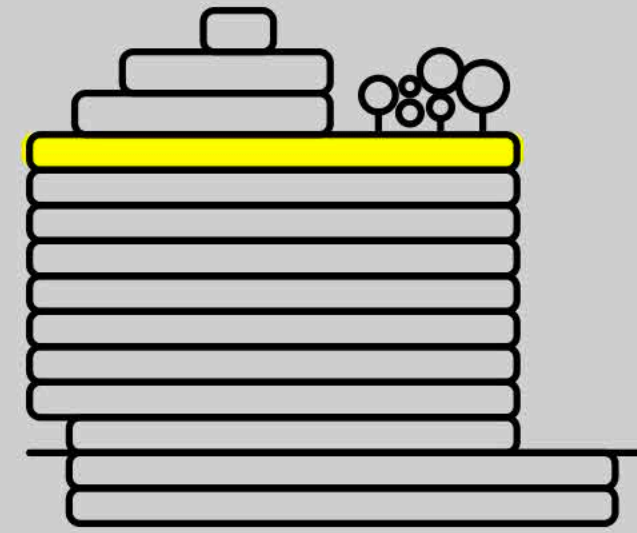

Plantas 8°

UF 01/
4 Ambientes
156 m²

UF 02/
3 Ambientes
84 m²

UF 03/
2 Ambientes
62 m²

UF 04/
4 Ambientes
131 m²

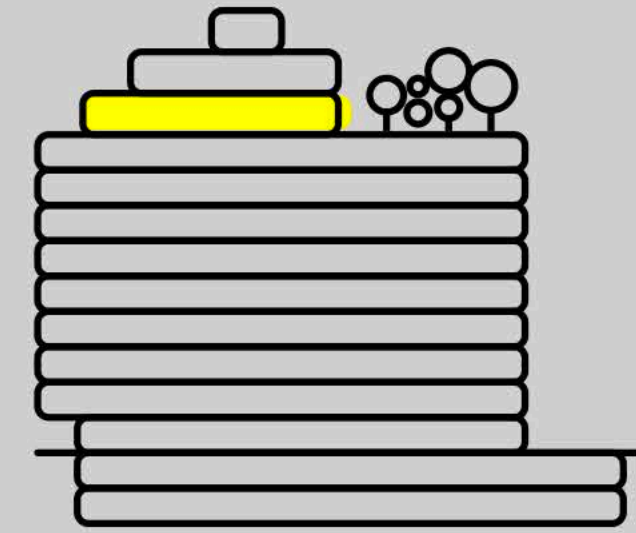

Planta 9°

UF 01/
3 Ambientes
149 m²

Sky Forest®
SUM
Work space
Laundry

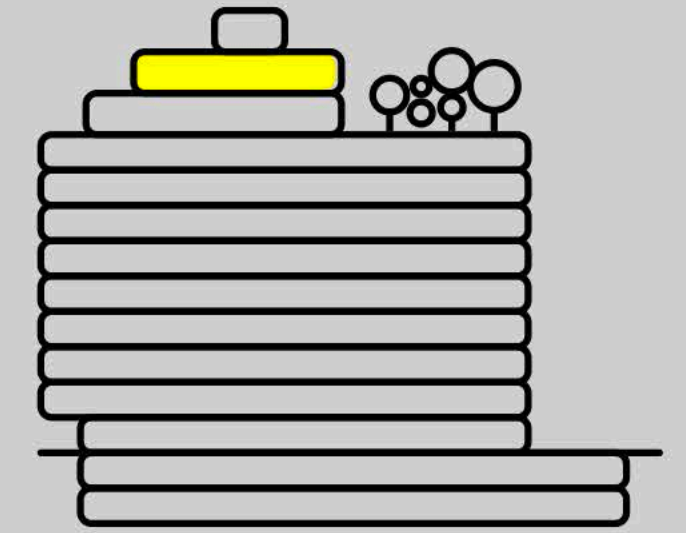

Planta 10°

Piscina
Solarium



Distribución de plantas

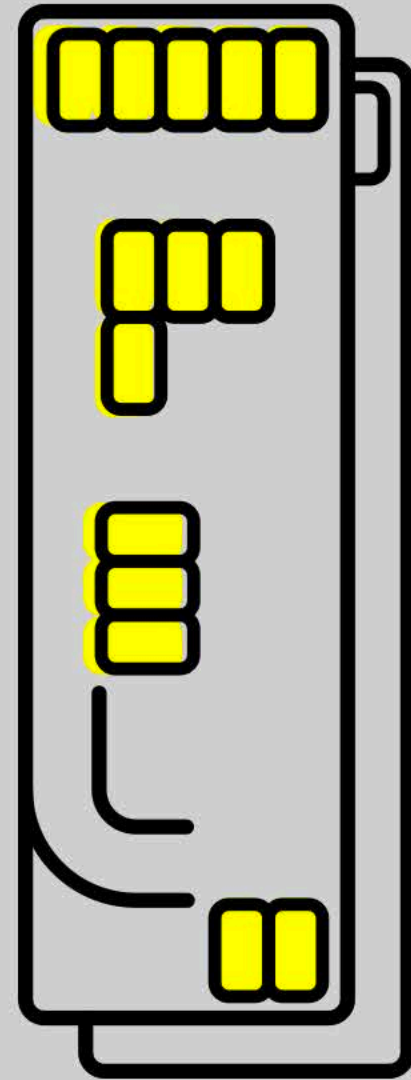

Subsuelos

-1
14 cocheras
Fijas por
Rampa

-2
14 cocheras
Fijas por
Rampa

Bike parking

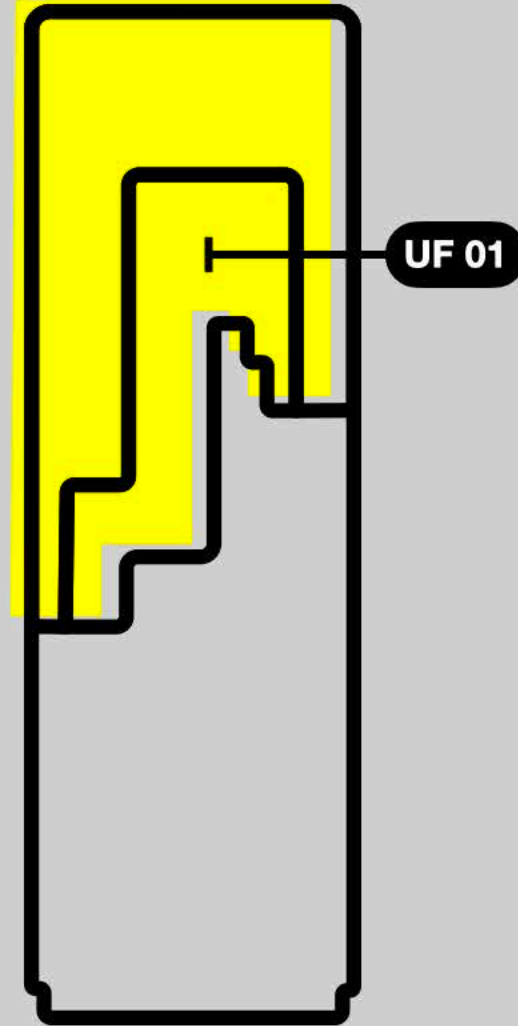

Planta Baja

UF 01
Casa
4 Ambientes
350 m²

Local
Comercial

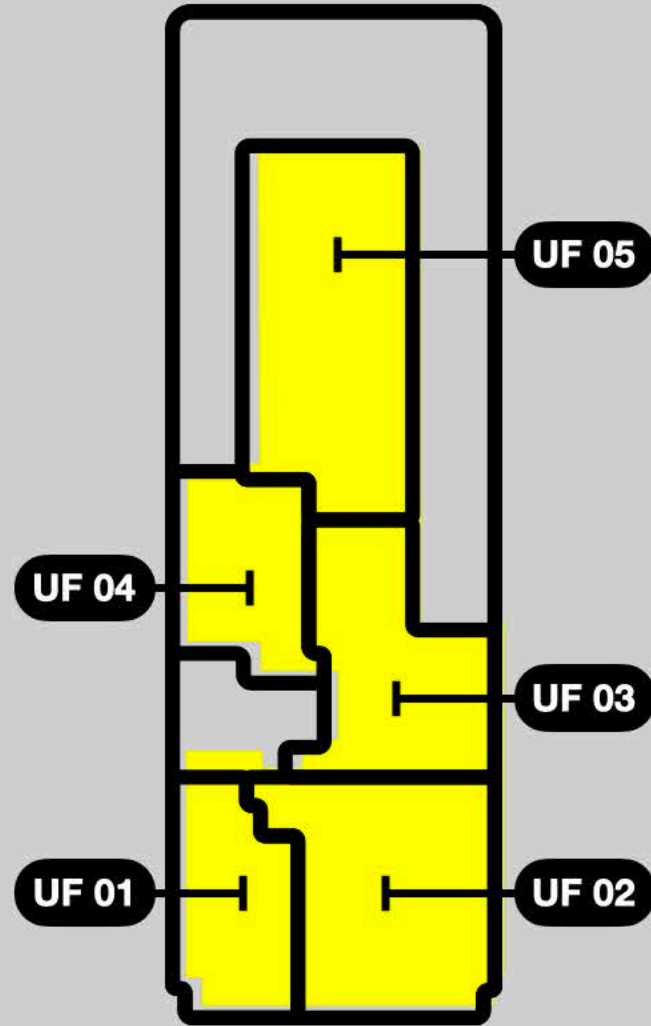

Plantas del 1° al 7°

UF 01/
2 Ambientes
65 m²

UF 02/
3 Ambientes
92 m²

UF 03/
3 Ambientes
84 m²

UF 04/
2 Ambientes
61 m²

UF 05/
4 Ambientes
131 m²

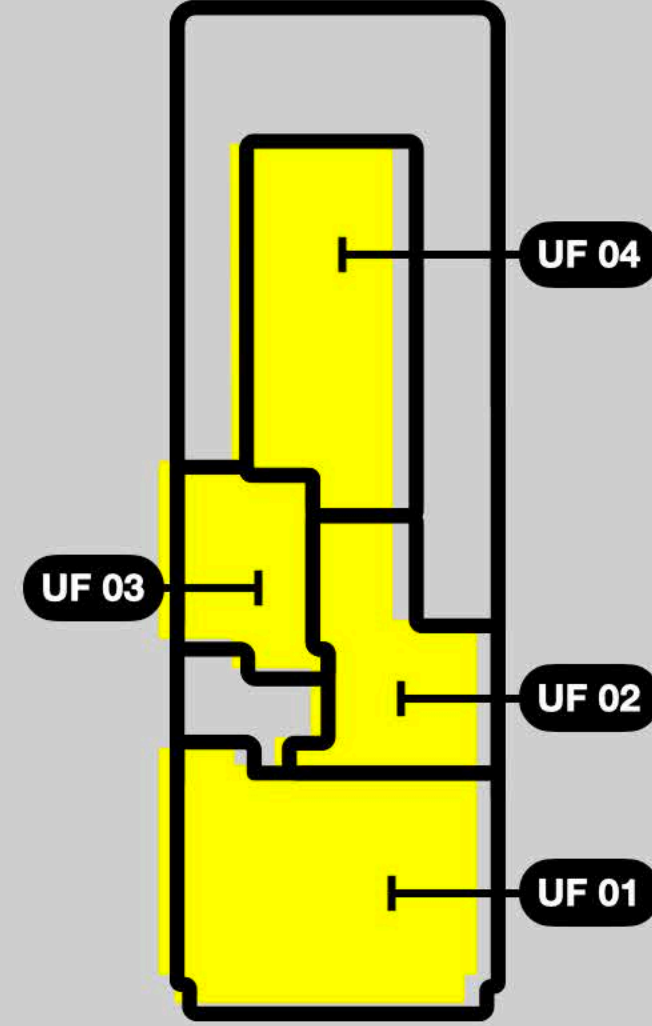

Planta 8°

UF 01/
4 Ambientes
156 m²

UF 02/
3 Ambientes
84 m²

UF 03/
2 Ambientes
62 m²

UF 04/
4 Ambientes
131 m²

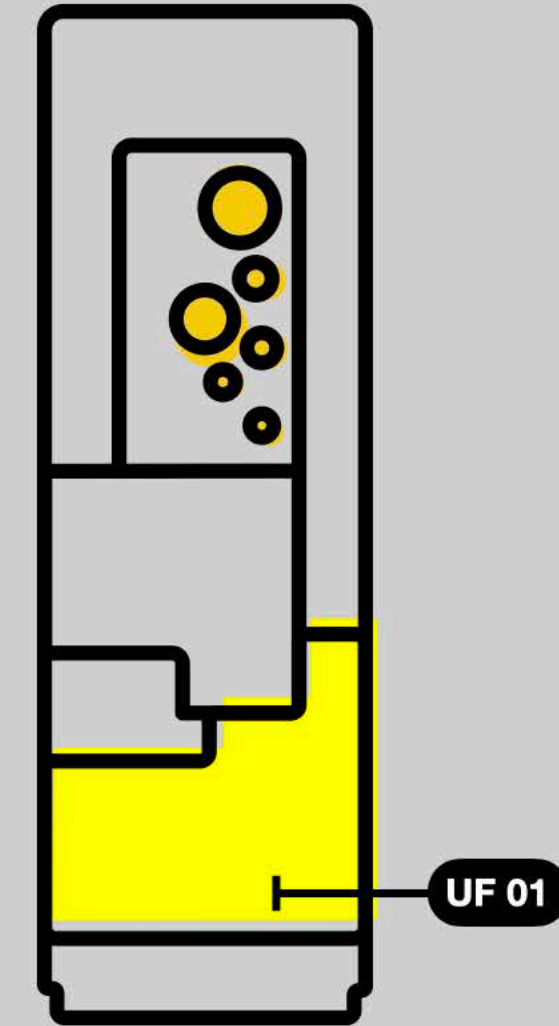

Planta 9°

UF 01/
3 Ambientes
149 m²

**Sky Forest®
SUM
Work space
Laundry**

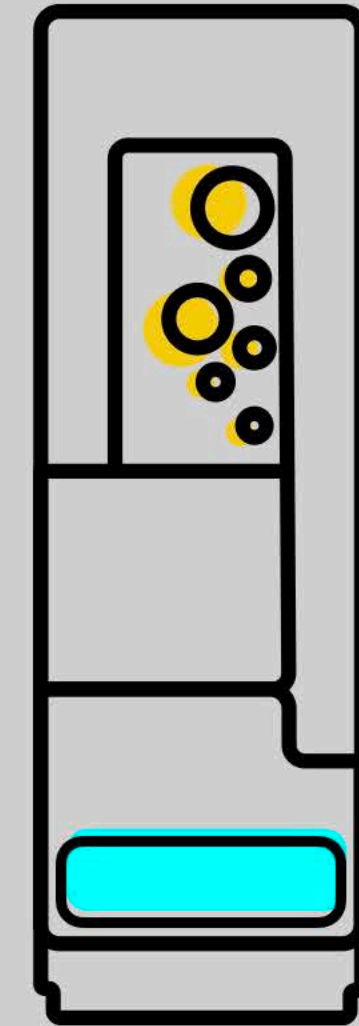

Planta 10°

**Piscina
Solarium**



Planta Baja

1 casa de 4 ambientes con
parrilla completa y jardín propio

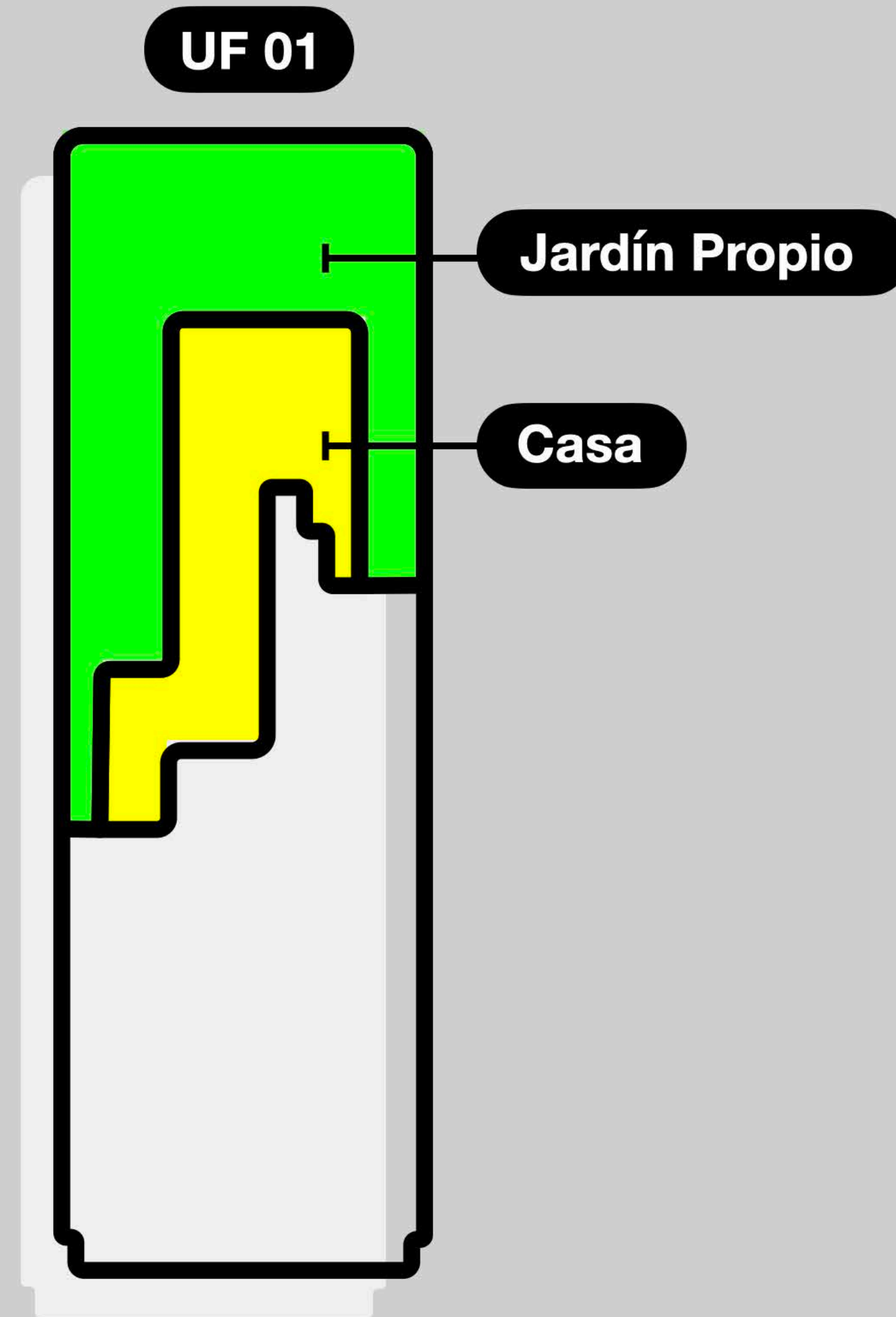
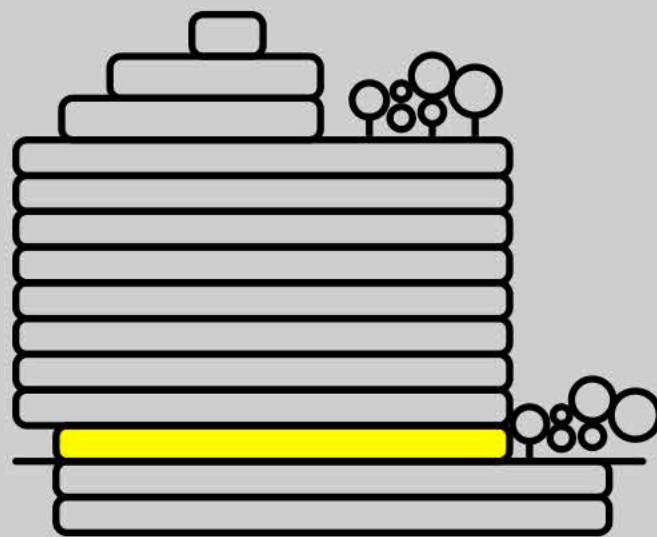
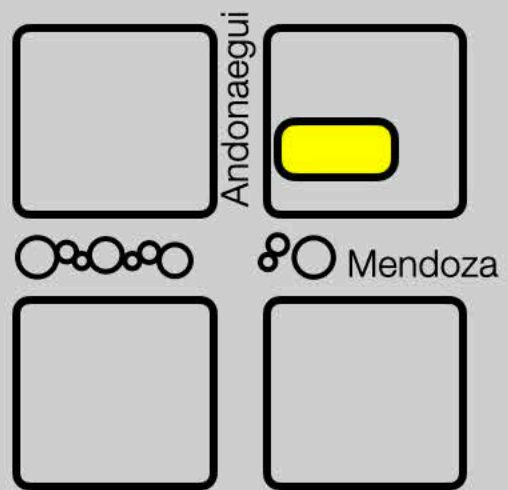

Unique
Rosbaco
Collection®

Planta Baja

UF 01

4 ambientes | Contrafrente

145 m2 cubiertos

205 m2 descubiertos

350 m2 totales

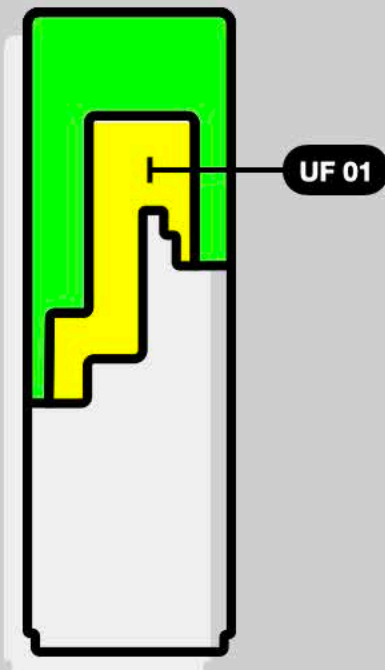

Noreste

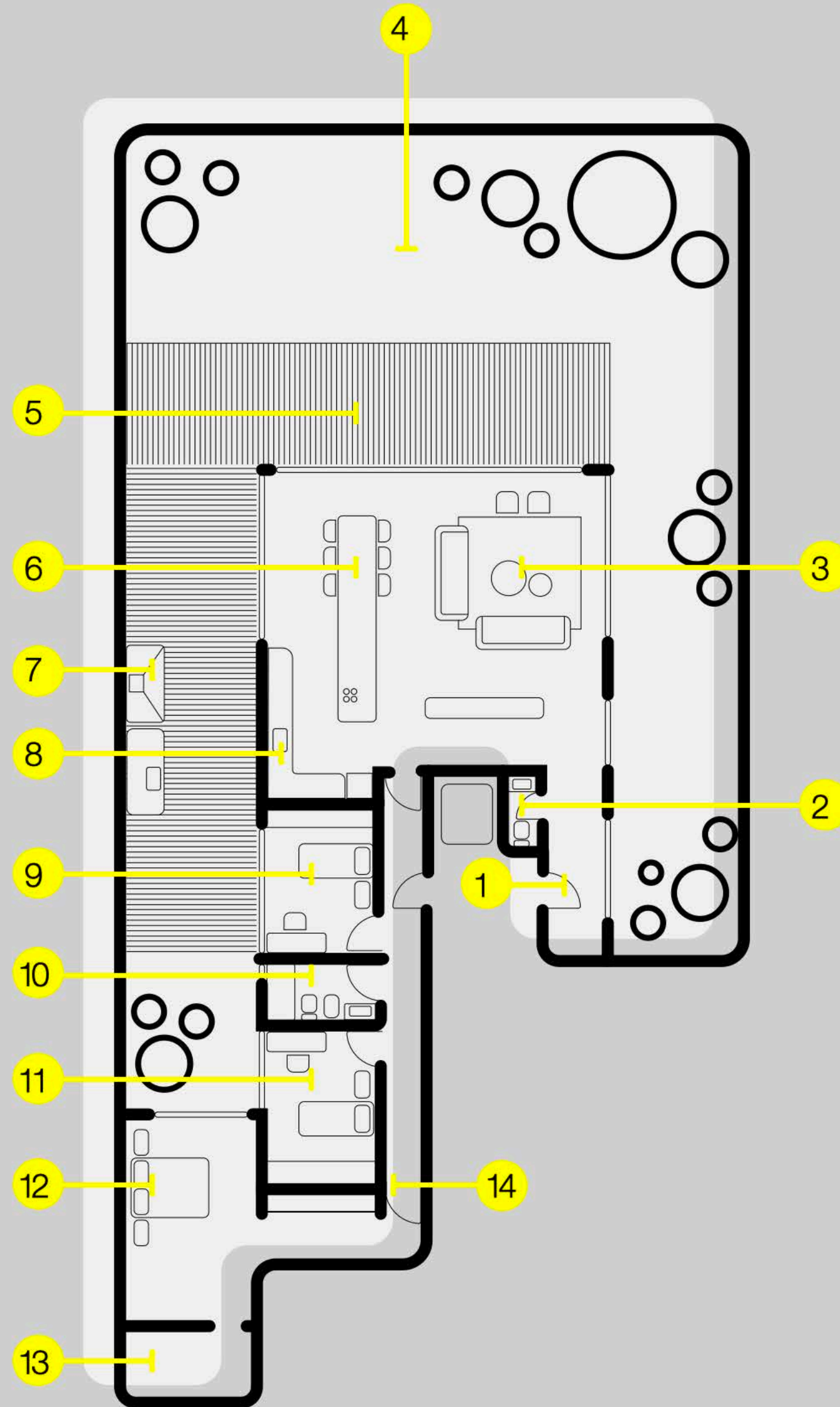

- 1 Doble Entrada
- 2 Toilete
- 3 Living
- 4 Jardín
- 5 Deck perimetral
- 6 Comedor integrado
- 7 Parrilla completa
- 8 Cocina
- 9 Dormitorio 1
- 10 Baño
- 11 Dormitorio 2
- 12 Master Suite
- 13 Baño
- 14 Vestidor

Unique
Rosbaco
Collection®

Plantas 1° a 7°

5 unidades por planta
de 2, 3 y 4 ambientes

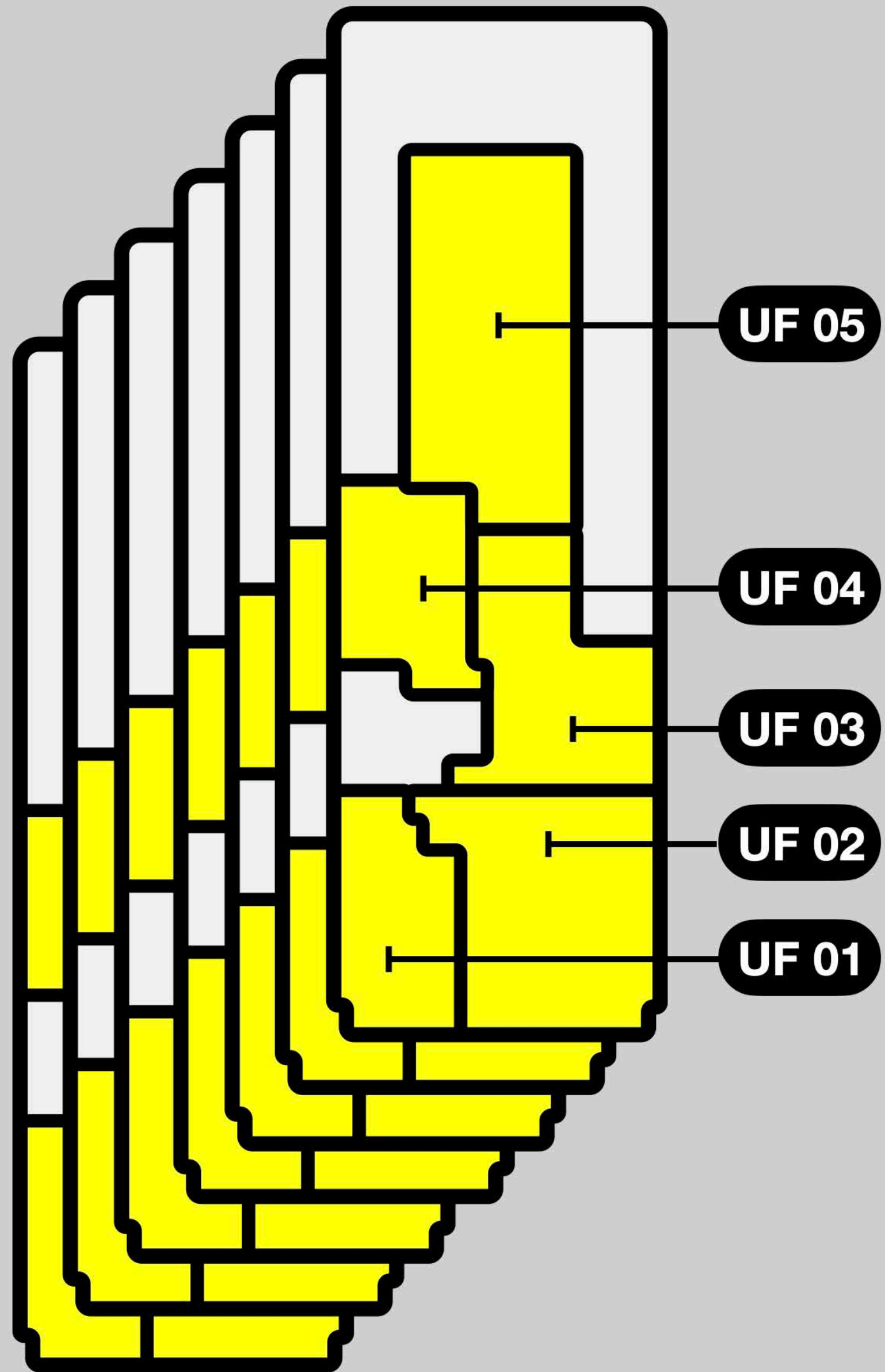
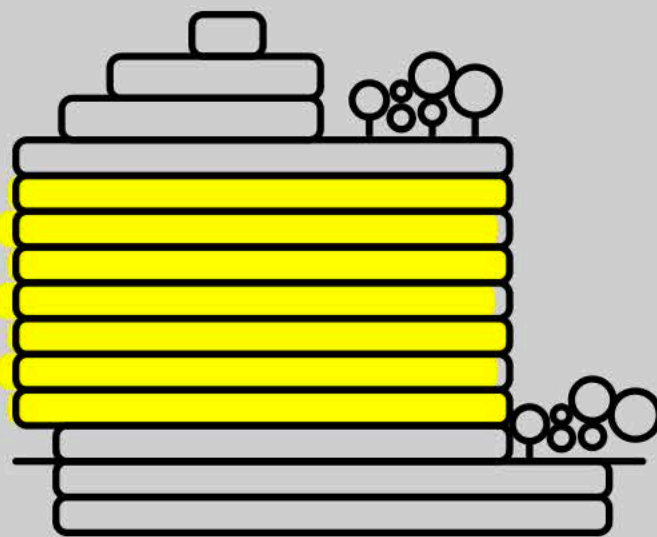
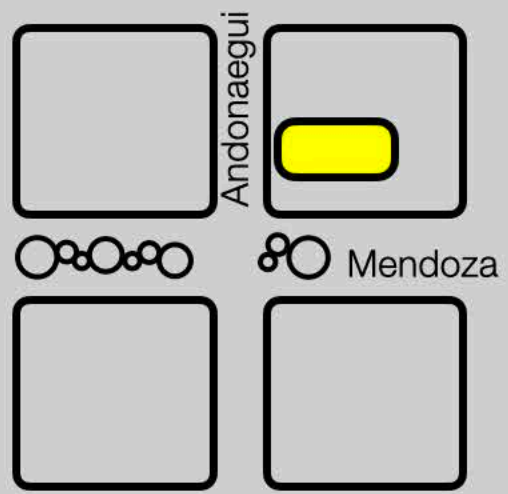

Plantas 1° a 7°

UF 01

2 ambientes | Frente

56 m2 cubiertos

9 m2 semicubiertos

65 m2 totales

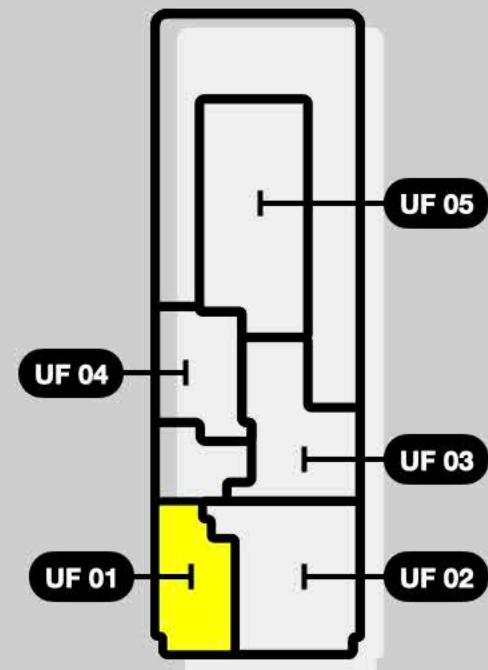

Sudoeste

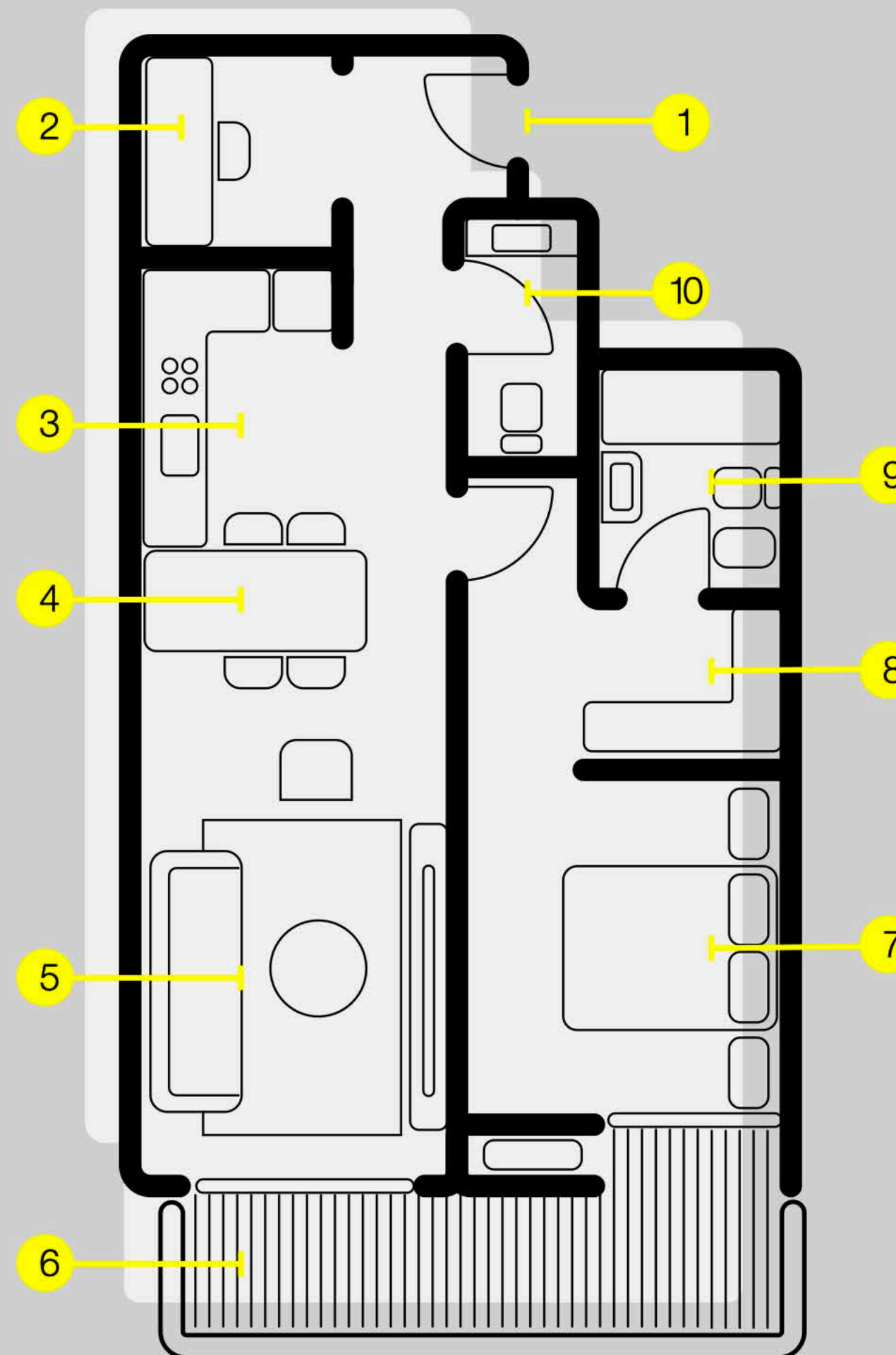

Unique
Rosbaco
Collection®

- 1 Entrada
- 2 Office
- 3 Cocina
- 4 Comedor integrado
- 5 Living
- 6 Balcón terraza
- 7 Master suite
- 8 Vestidor
- 9 Baño
- 10 Toilete

Plantas 1° a 7°

UF 02

3 ambientes | Frente

78 m2 cubiertos

14 m2 semicubiertos

92 m2 totales

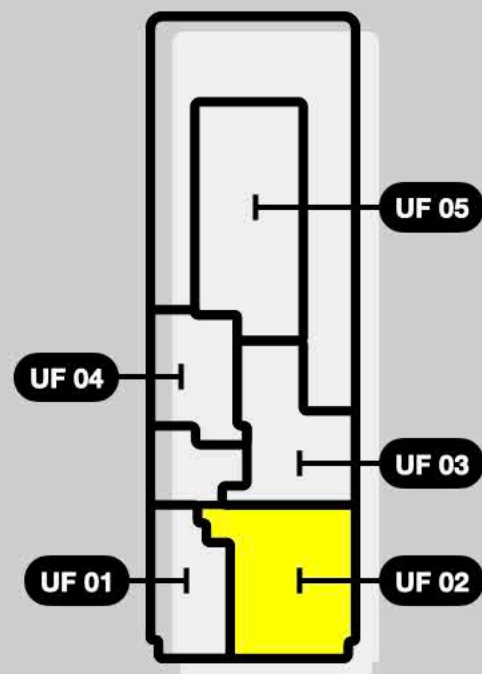

Sudoeste

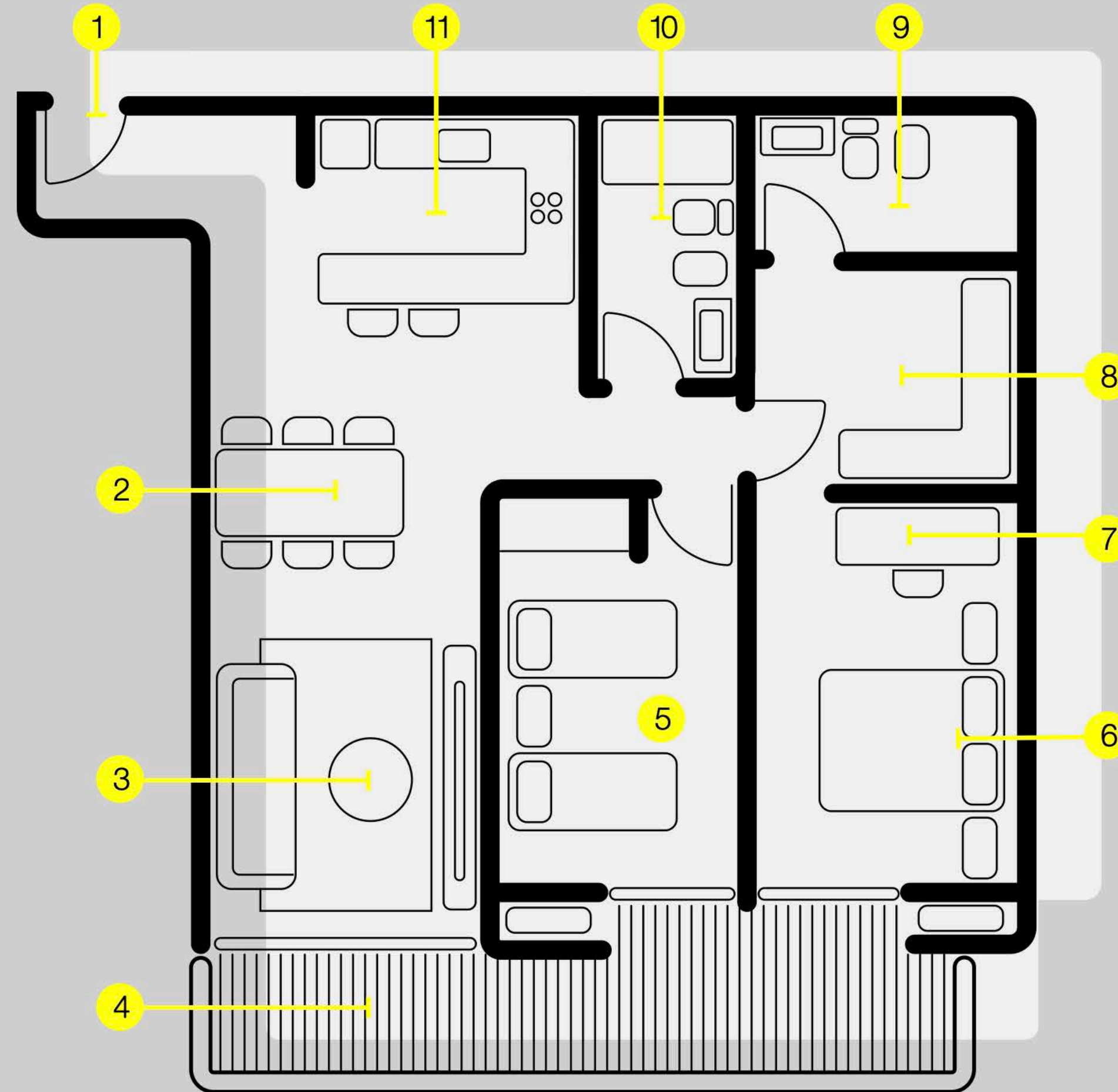

- 1 Entrada
- 2 Comedor
- 3 Living
- 4 Balcón terraza
- 5 Dormitorio
- 6 Master suite
- 7 Office
- 8 Vestidor
- 9 Baño
- 10 Baño
- 11 Cocina

Unique
Rosbaco
Collection®

Plantas 1° a 7°

UF 03

3 ambientes | Lateral

76 m² cubiertos

8 m² semicubiertos

84 m² totales

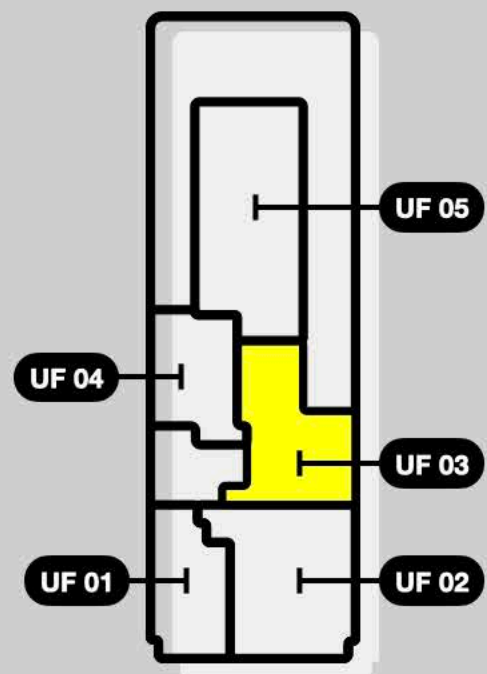

Noreste

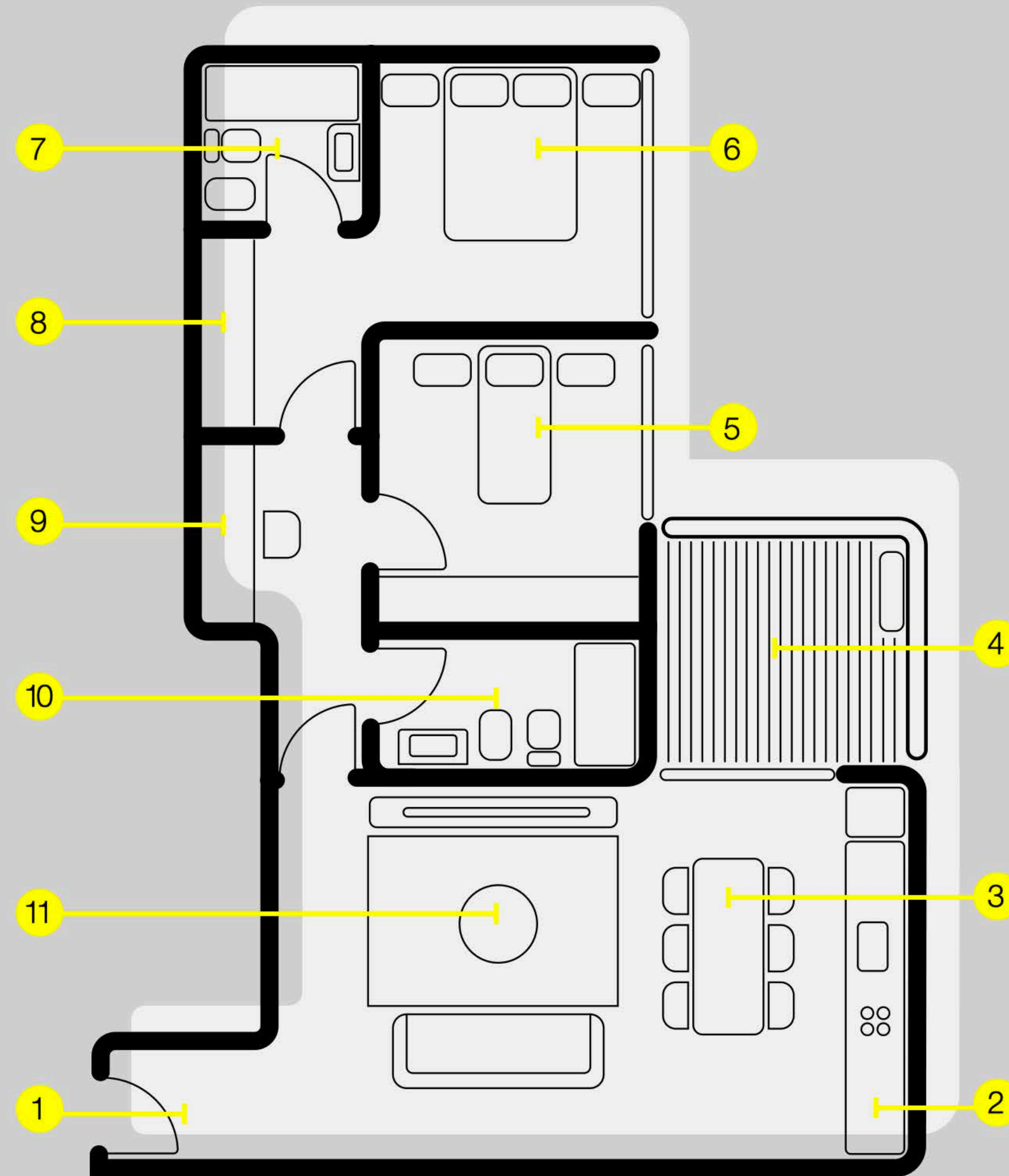

Unique
Rosbaco
Collection®

- 1 Entrada
- 2 Cocina
- 3 Comedor
- 4 Balcón terraza
- 5 Dormitorio
- 6 Master suite
- 7 Baño
- 8 Vestidor
- 9 Office
- 10 Baño
- 11 Living

Plantas 1° a 7°

UF 04

2 ambientes | Lateral

54 m² cubiertos

7 m² semicubiertos

61 m² totales

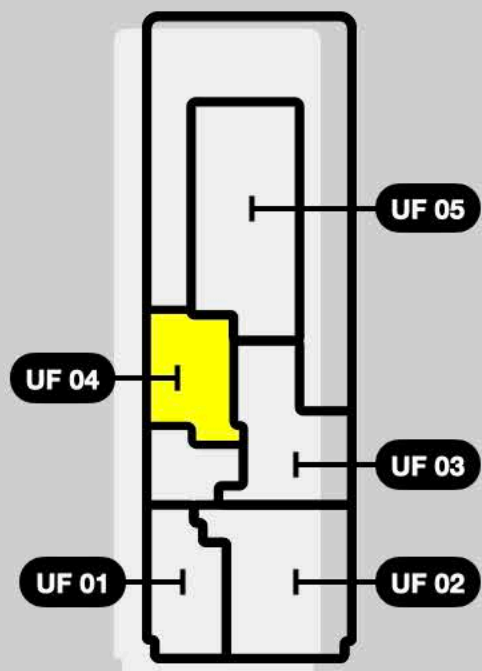

Noreste

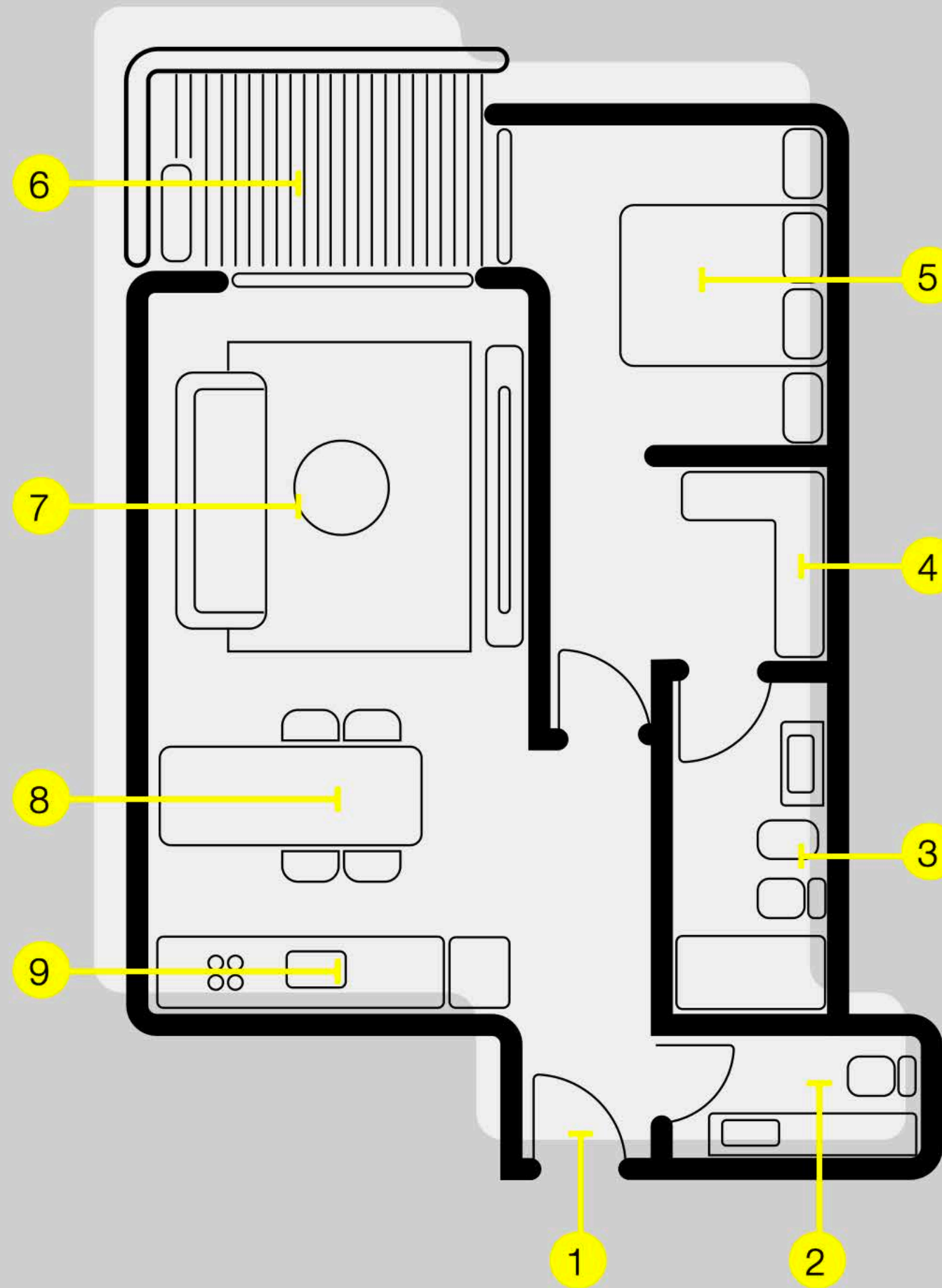

- 1 Entrada
- 2 Toilete
- 3 Baño
- 4 Vestidor
- 5 Master suite
- 6 Balcón Terraza
- 7 Living
- 8 Comedor
- 9 Cocina

Unique
Rosbaco
Collection®

Plantas 1° a 7°

UF 05

4 ambientes | Contrafrente

120 m2 cubiertos

11 m2 semicubiertos

131 m2 totales

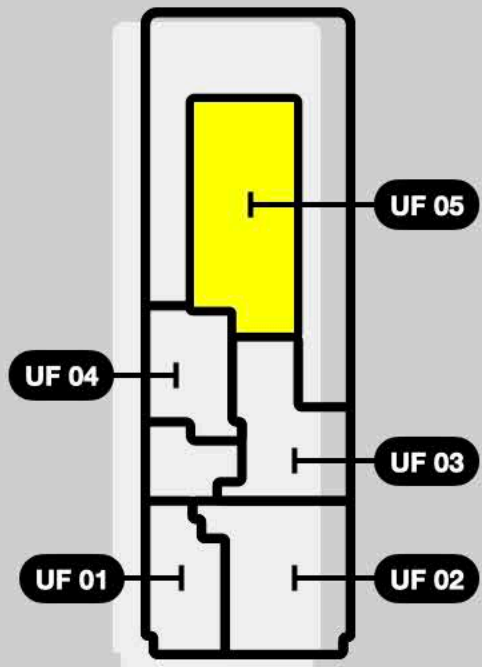

Noreste

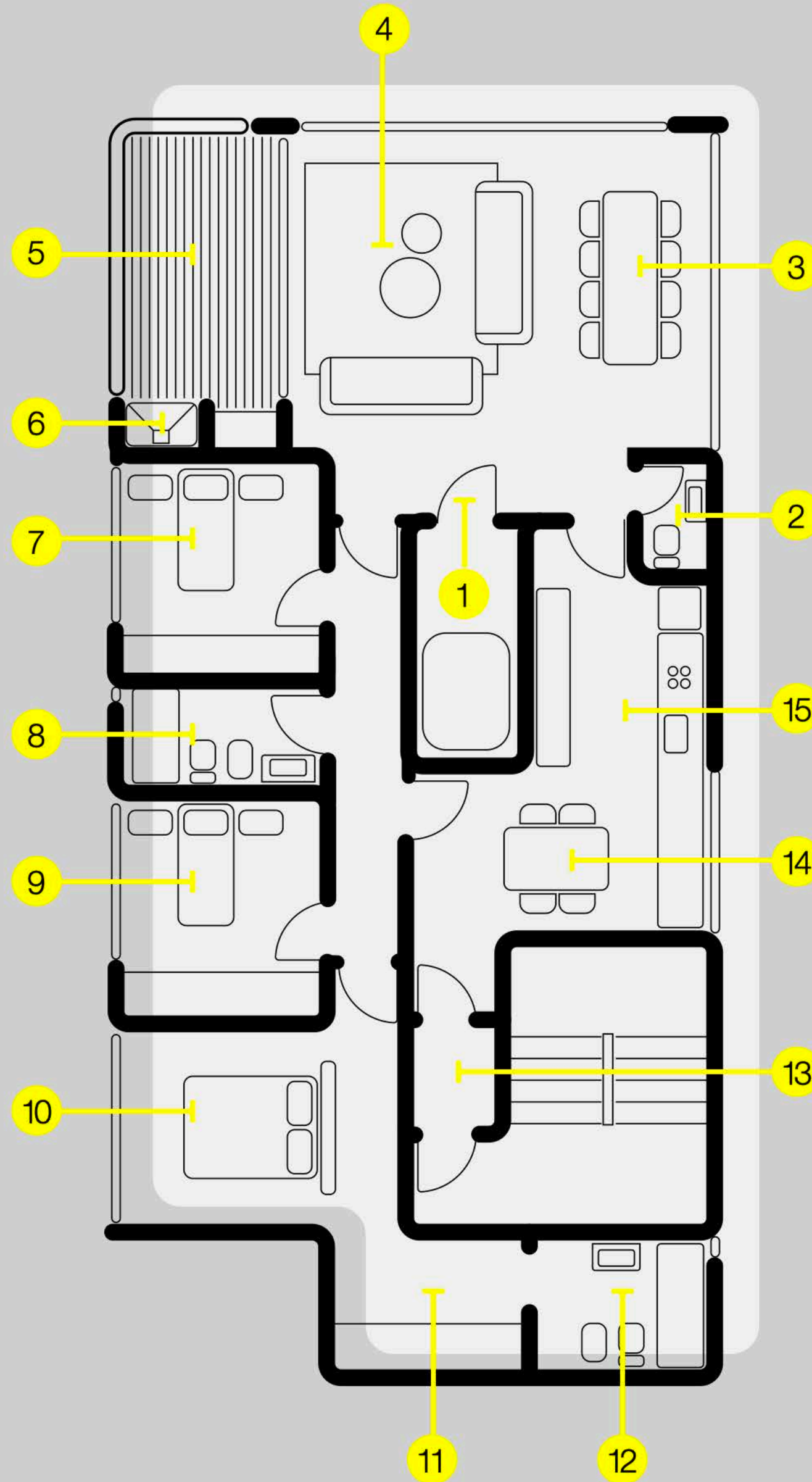

Unique
Rosbaco
Collection®

- 1 Palier privado
- 2 Toilete
- 3 Comedor
- 4 Living
- 5 Balcón terraza
- 6 Parilla
- 7 Dormitorio 1
- 8 Baño
- 9 Dormitorio 2
- 10 Master suite
- 11 Vestidor
- 12 Baño
- 13 Entrada de servicio
- 14 Vestidor
- 15 Cocina

Planta 8°

4 unidades de
2, 3 y 4 ambientes

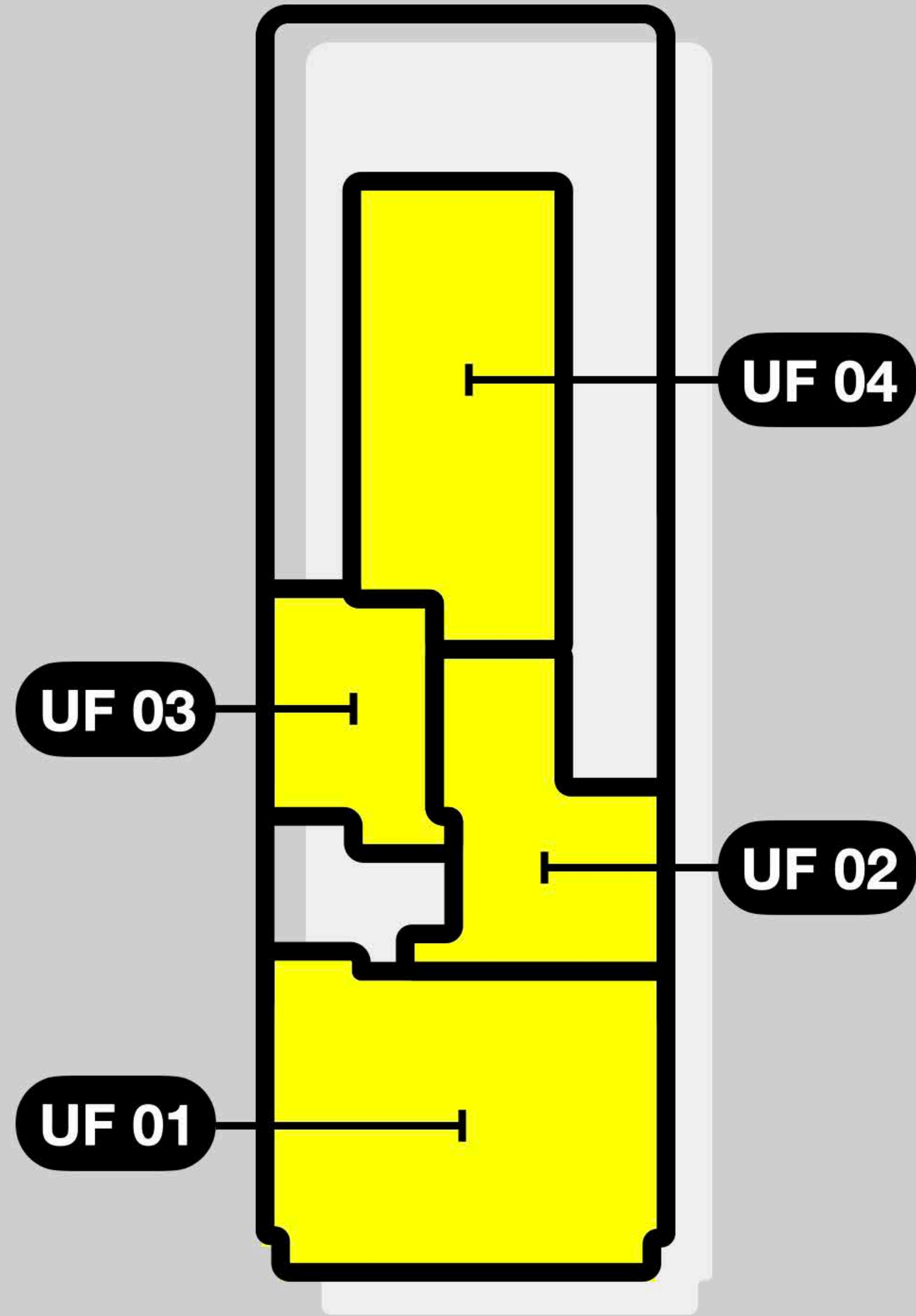
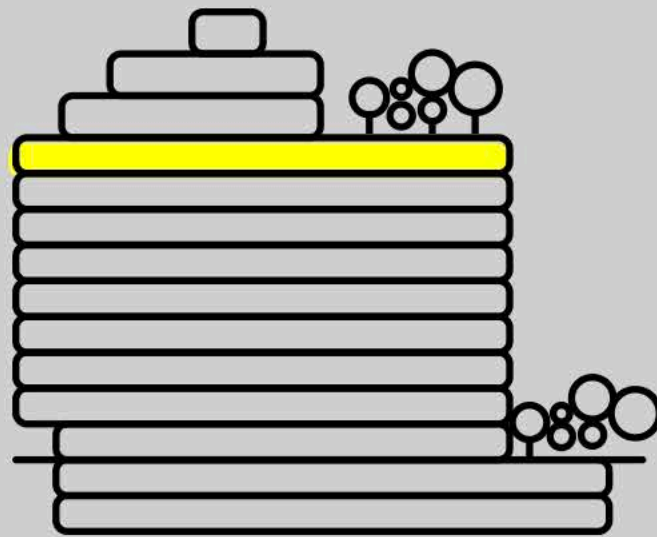
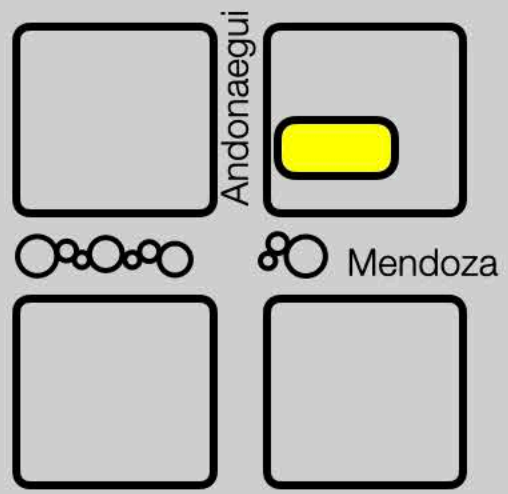

Planta 8°

UF 01

4 ambientes | Frente

106 m2 cubiertos

50 m2 descubiertos

156 m2 totales

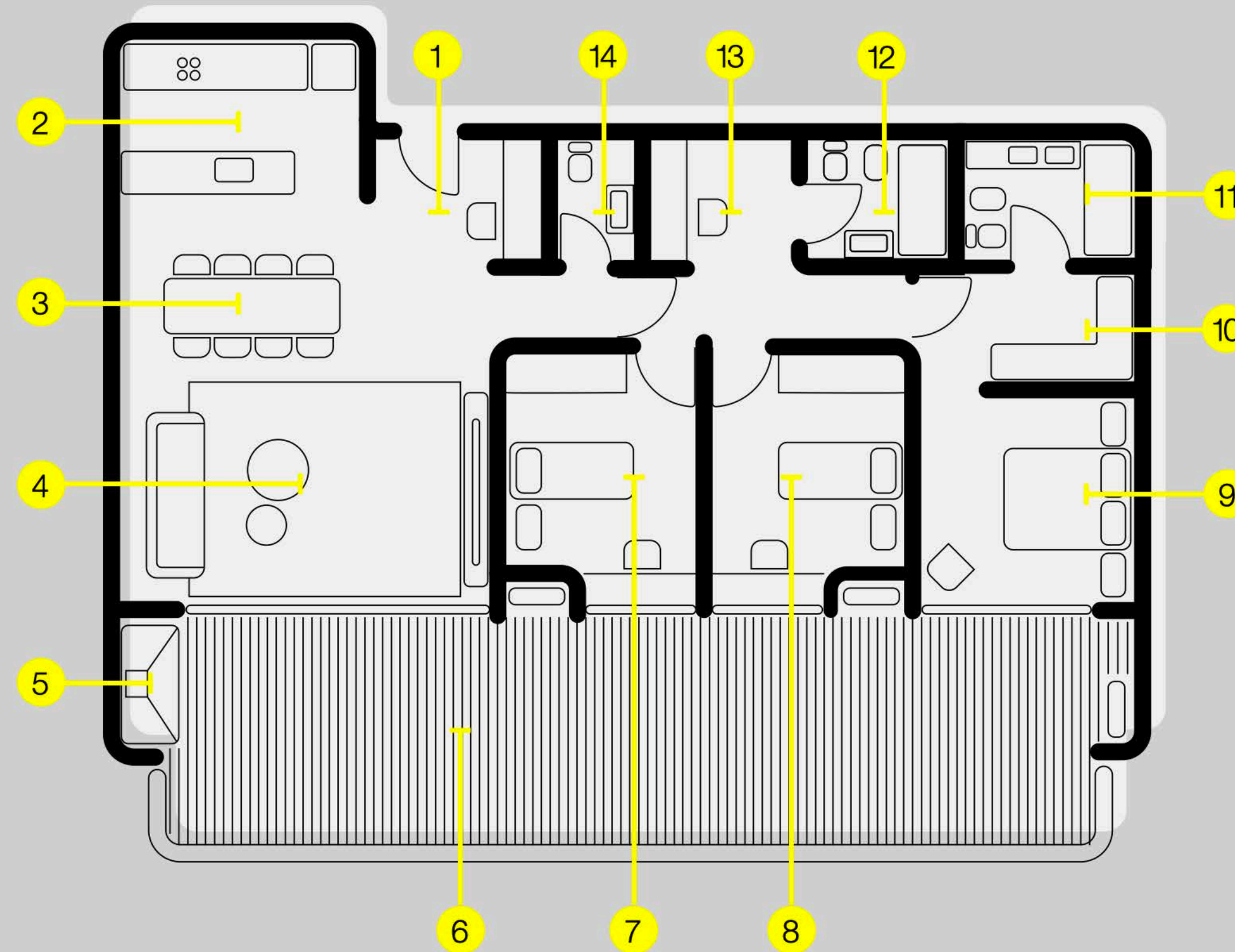
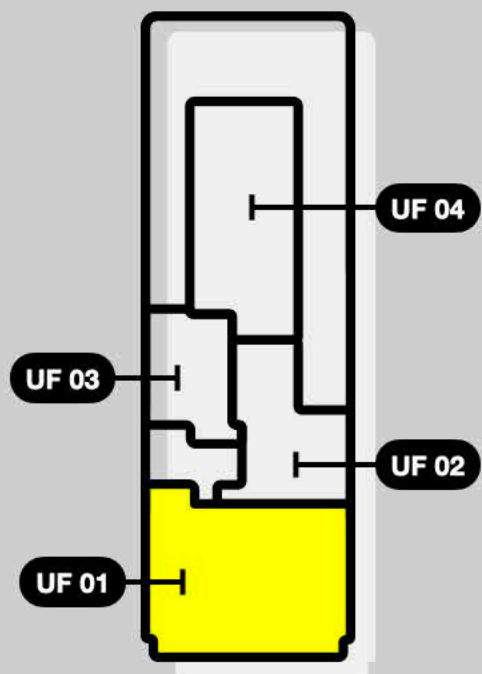

- 1 Entrada
- 2 Cocina
- 3 Comedor
- 4 Living
- 5 Parrilla
- 6 Balcón Terraza
- 7 Dormitorio 1
- 8 Dormitorio 2
- 9 Master Suite
- 10 Vestidor
- 11 Baño
- 12 Baño
- 13 Office
- 14 Toilete



Sudoeste

Planta 8°

UF 02

3 ambientes | Lateral

76 m2 cubiertos

8 m2 semicubiertos

84 m2 totales

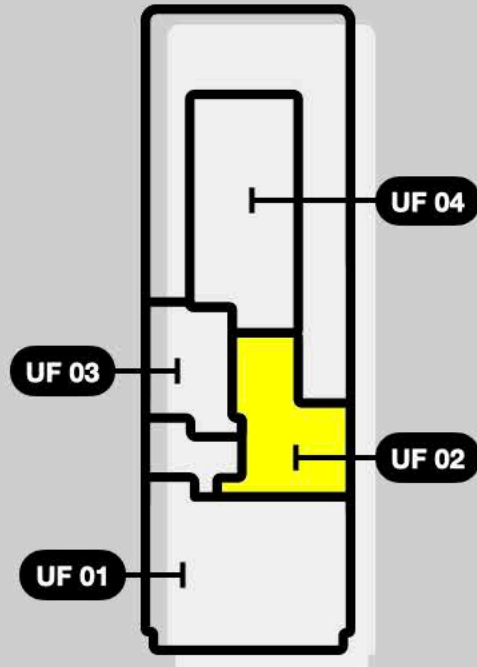

Noreste

Unique
Rosbaco
Collection®

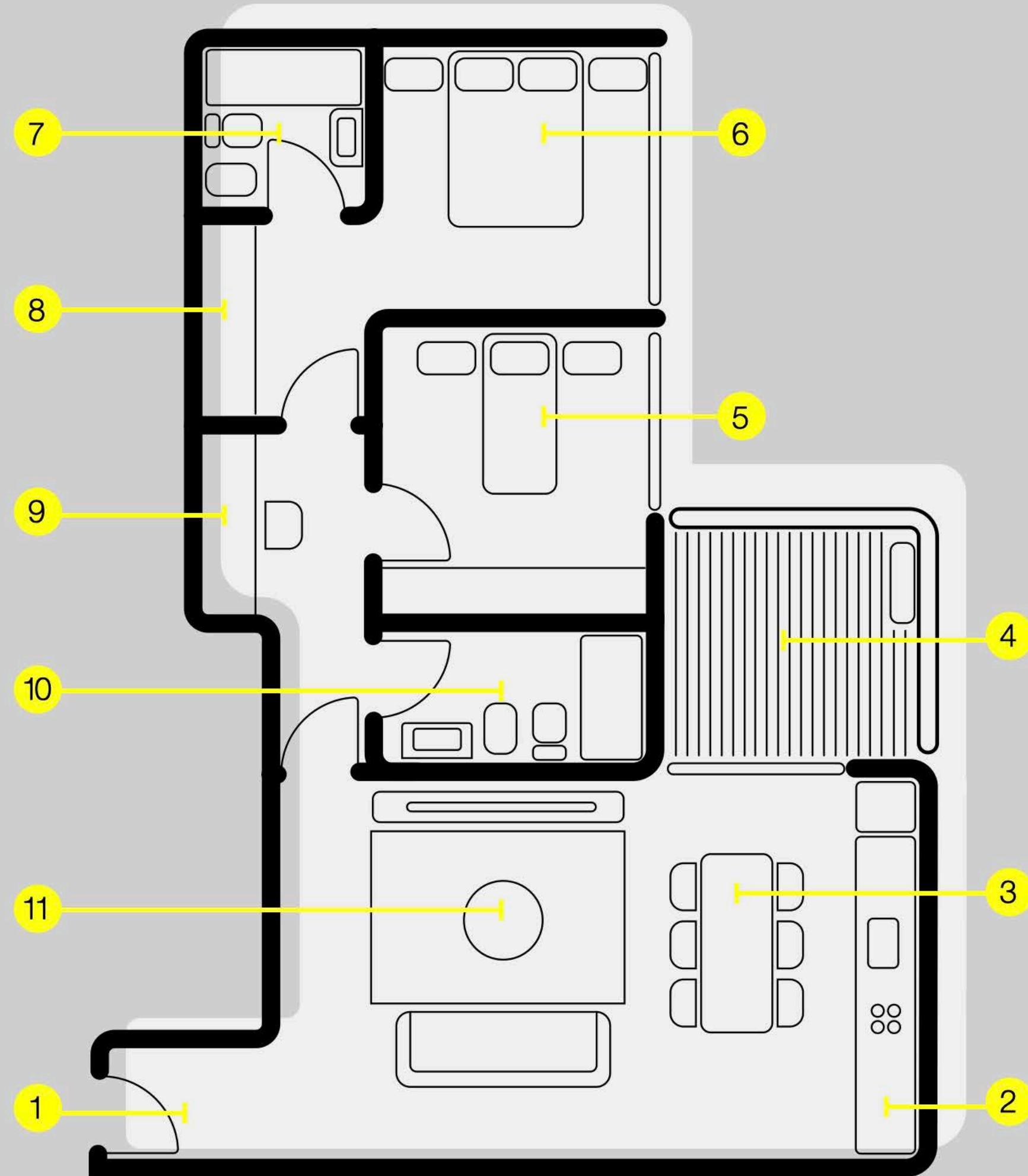

- 1 Entrada
- 2 Cocina
- 3 Comedor
- 4 Balcón terraza
- 5 Dormitorio
- 6 Master suite
- 7 Baño
- 8 Vestidor
- 9 Office
- 10 Baño
- 11 Living

Planta 8°

UF 03

2 ambientes | Lateral

55 m2 cubiertos

7 m2 semicubiertos

62 m2 totales

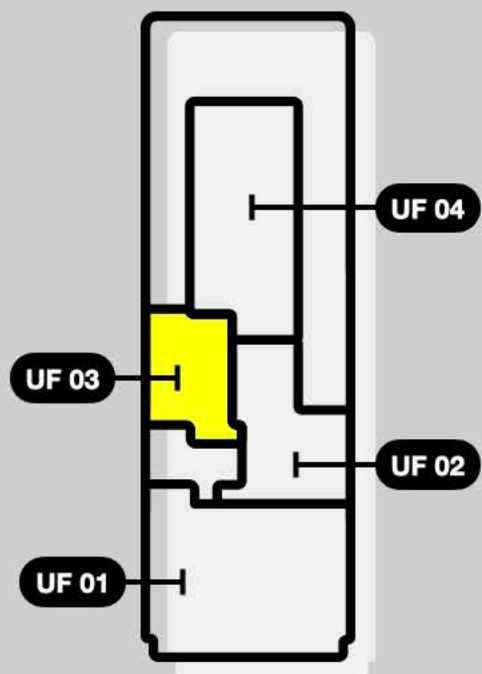

Noreste

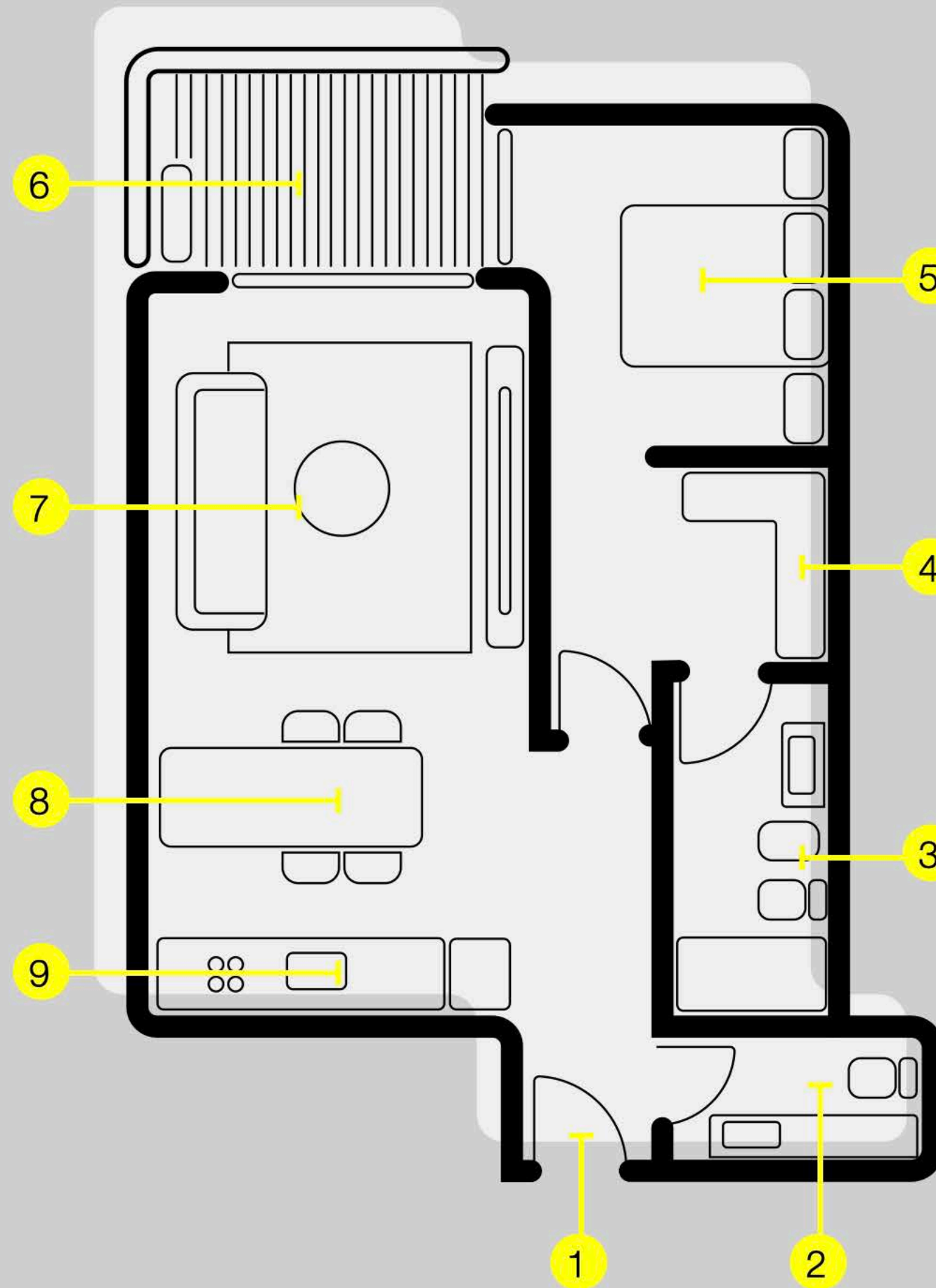

- 1 Entrada
- 2 Toilette
- 3 Baño
- 4 Vestidor
- 5 Master suite
- 6 Balcón Terraza
- 7 Living
- 8 Comedor
- 9 Cocina



Planta 8°

UF 04

4 ambientes | Contrafrente

120 m2 cubiertos

11 m2 semicubiertos

131 m2 totales

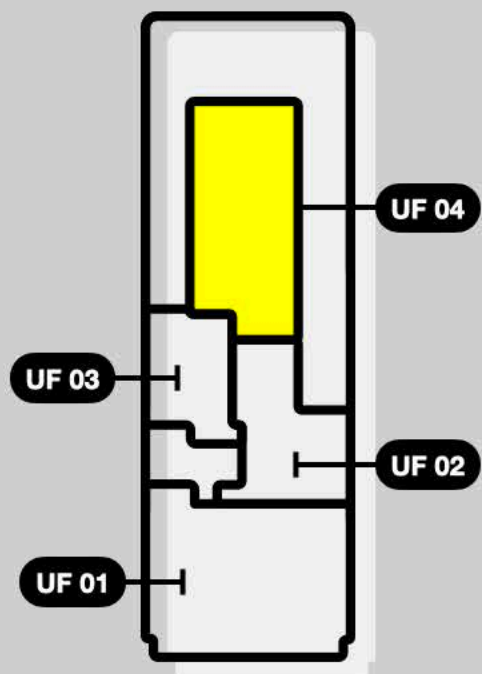

Noreste

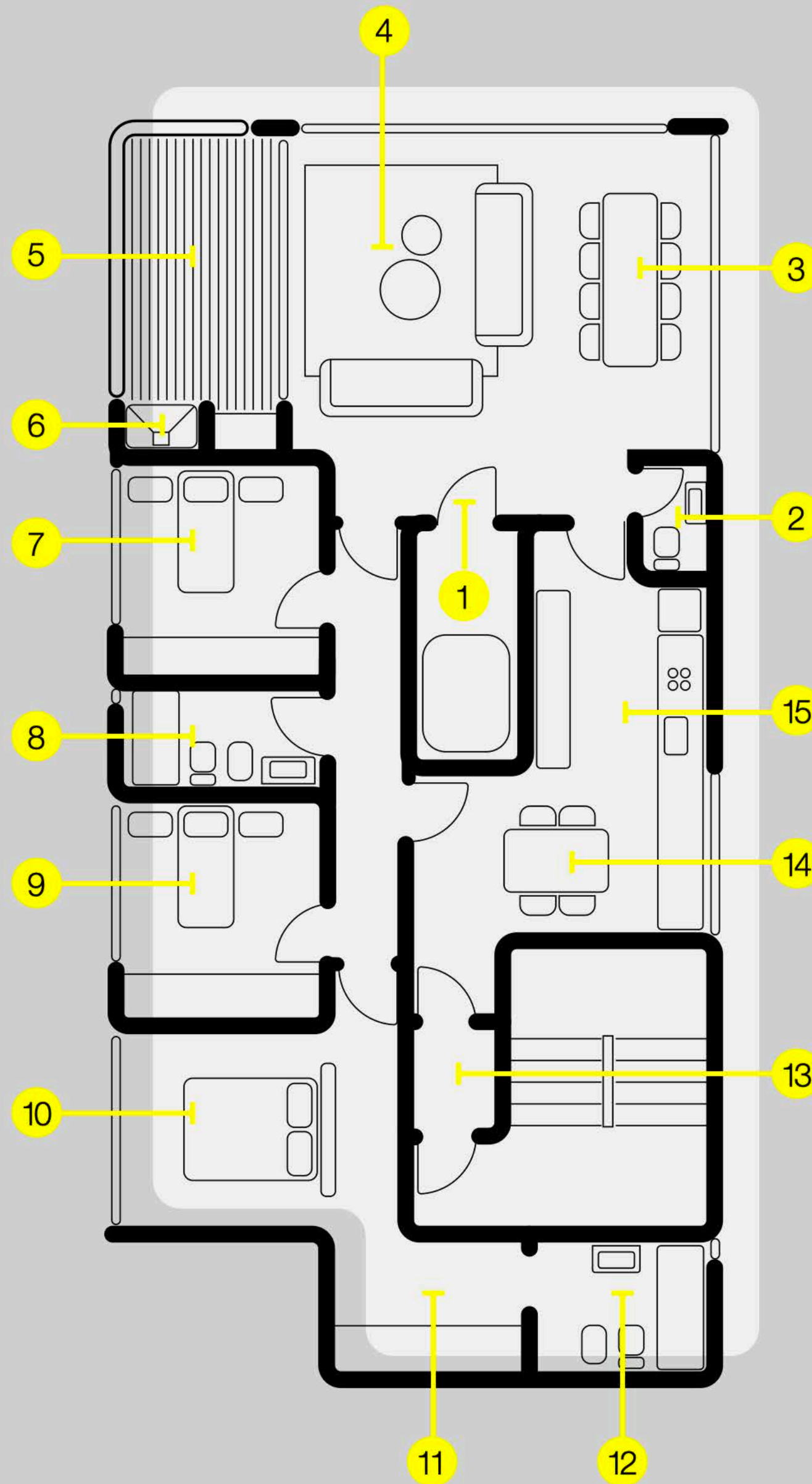

- 1 Palier privado
- 2 Toilete
- 3 Comedor
- 4 Living
- 5 Balcón terraza
- 6 Parilla
- 7 Dormitorio 1
- 8 Baño
- 9 Dormitorio 2
- 10 Master suite
- 11 Vestidor
- 12 Baño
- 13 Entrada de servicio
- 14 Vestidor
- 15 Cocina

Unique
Rosbaco
Collection®

Planta 9°

1 Unidad de 3 ambientes

SUM

Workplace

Sky Forest

Laundry

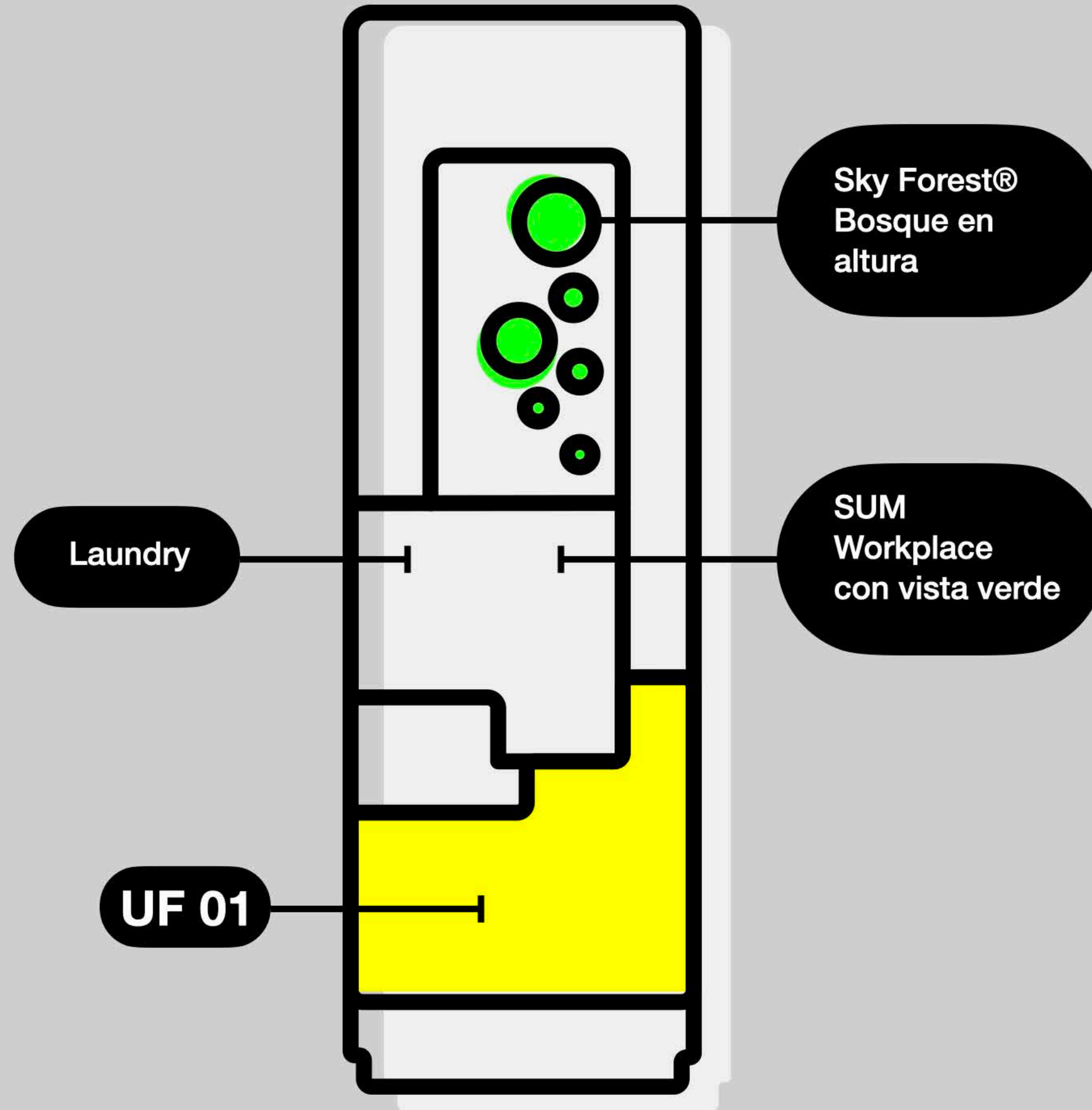
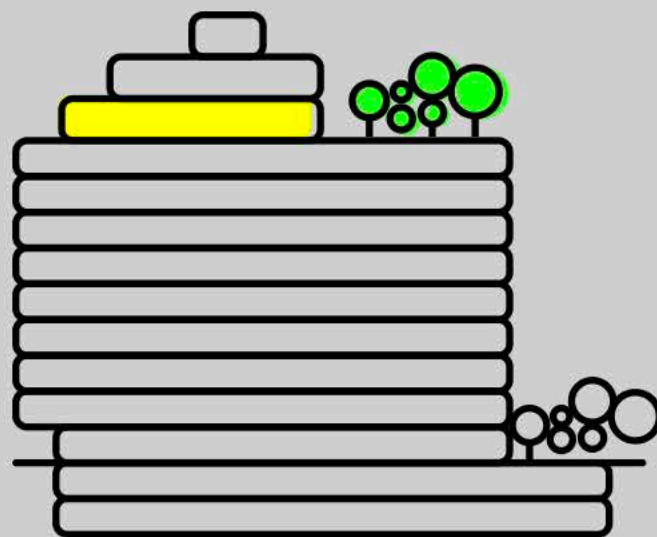
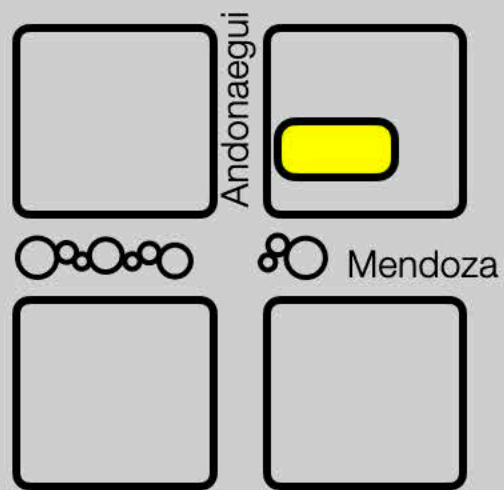

Planta 9°

UF 01

3 ambientes | Frente

114 m2 cubiertos

35 m2 descubiertos

149 m2 totales

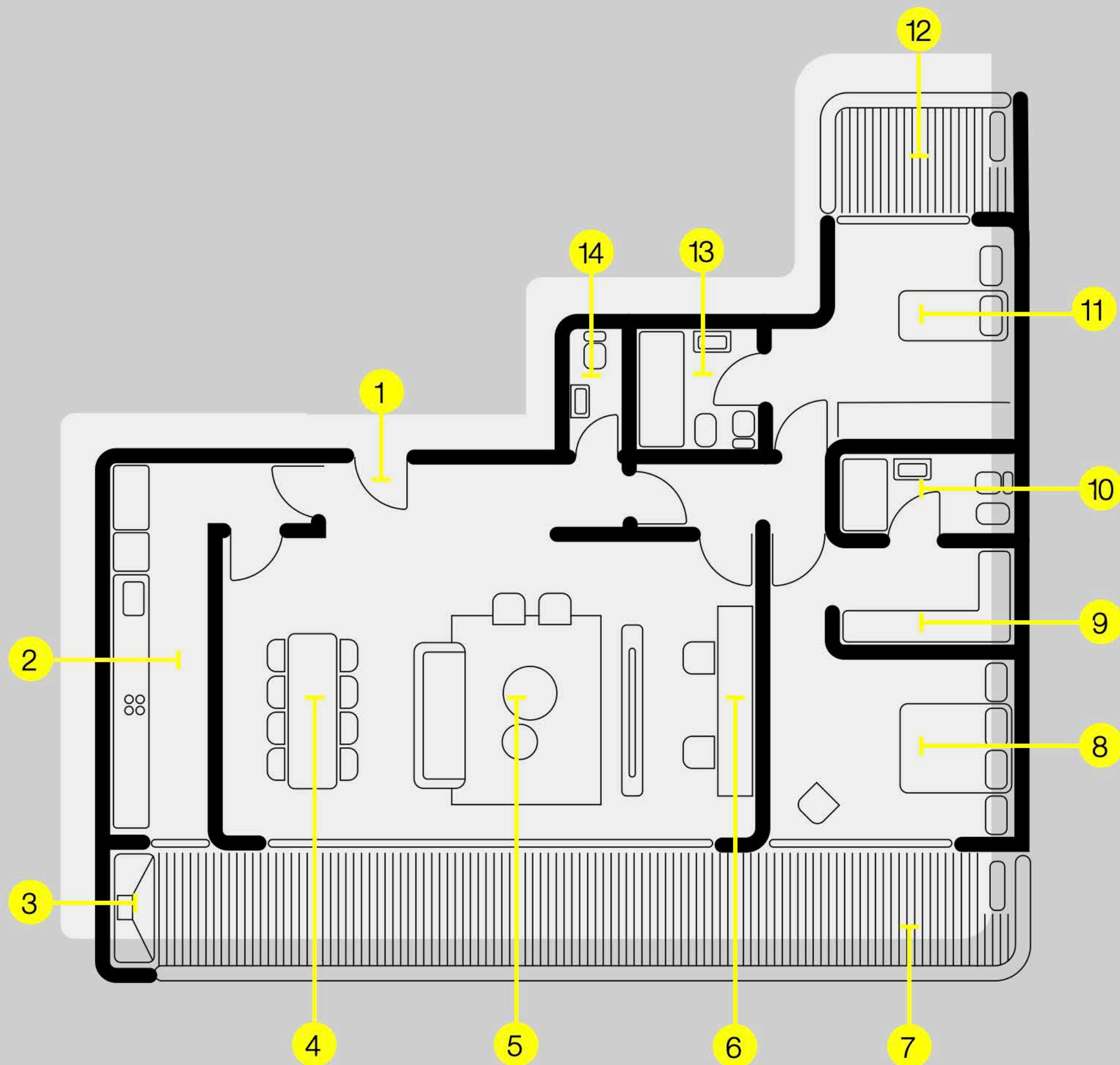
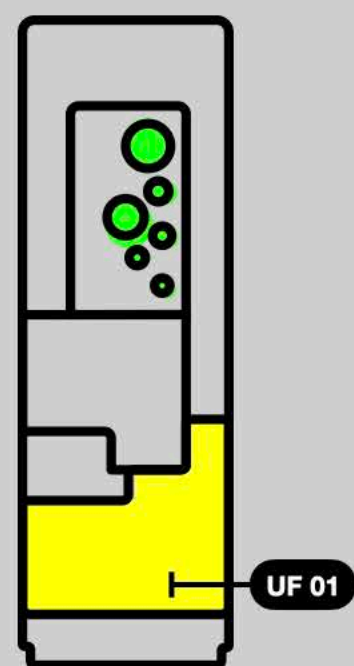

- 1 Entrada
- 2 Cocina
- 3 Parrilla
- 4 Comedor
- 5 Living
- 6 Office
- 7 Balcón terraza 1
- 8 Master Suite
- 9 Vestidor
- 10 Baño
- 11 Dormitorio
- 12 Balcón terraza 2
- 13 Baño
- 14 Toilette



Sudoeste

Planta 10°

Relax
Solarium
Piscina

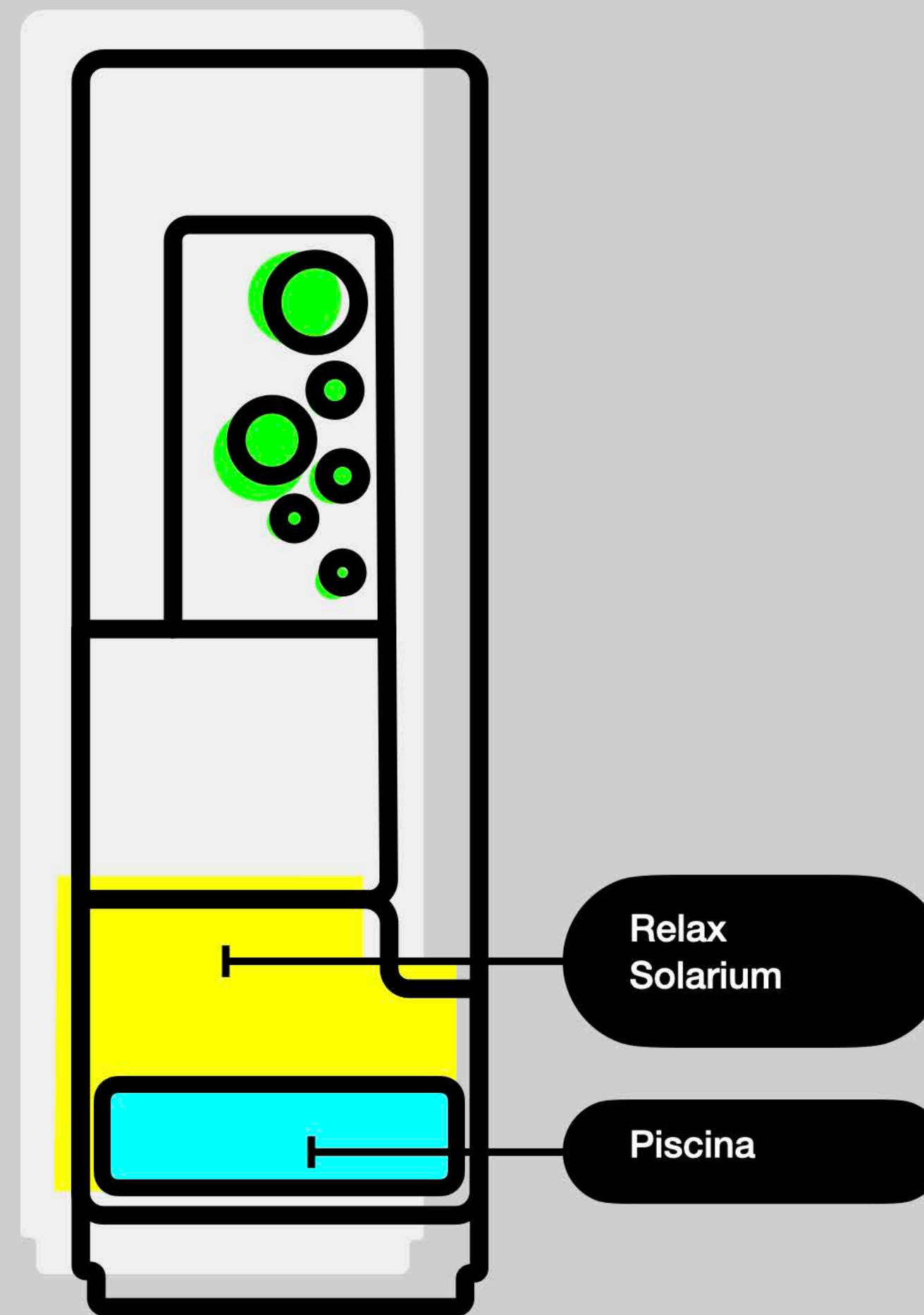
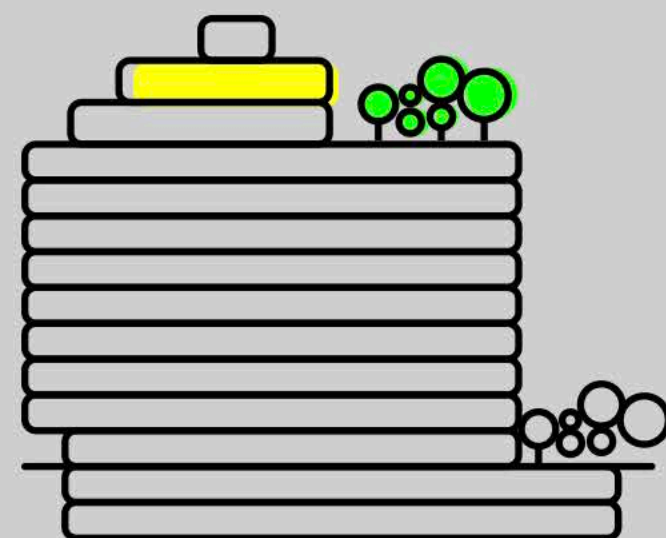
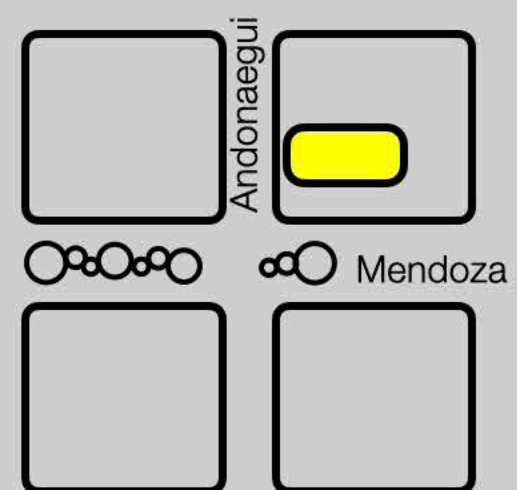

Subsuelos

Nivel -1 por rampa

14 cocheras

Nivel -2 por rampa

14 cocheras

Bike Parking

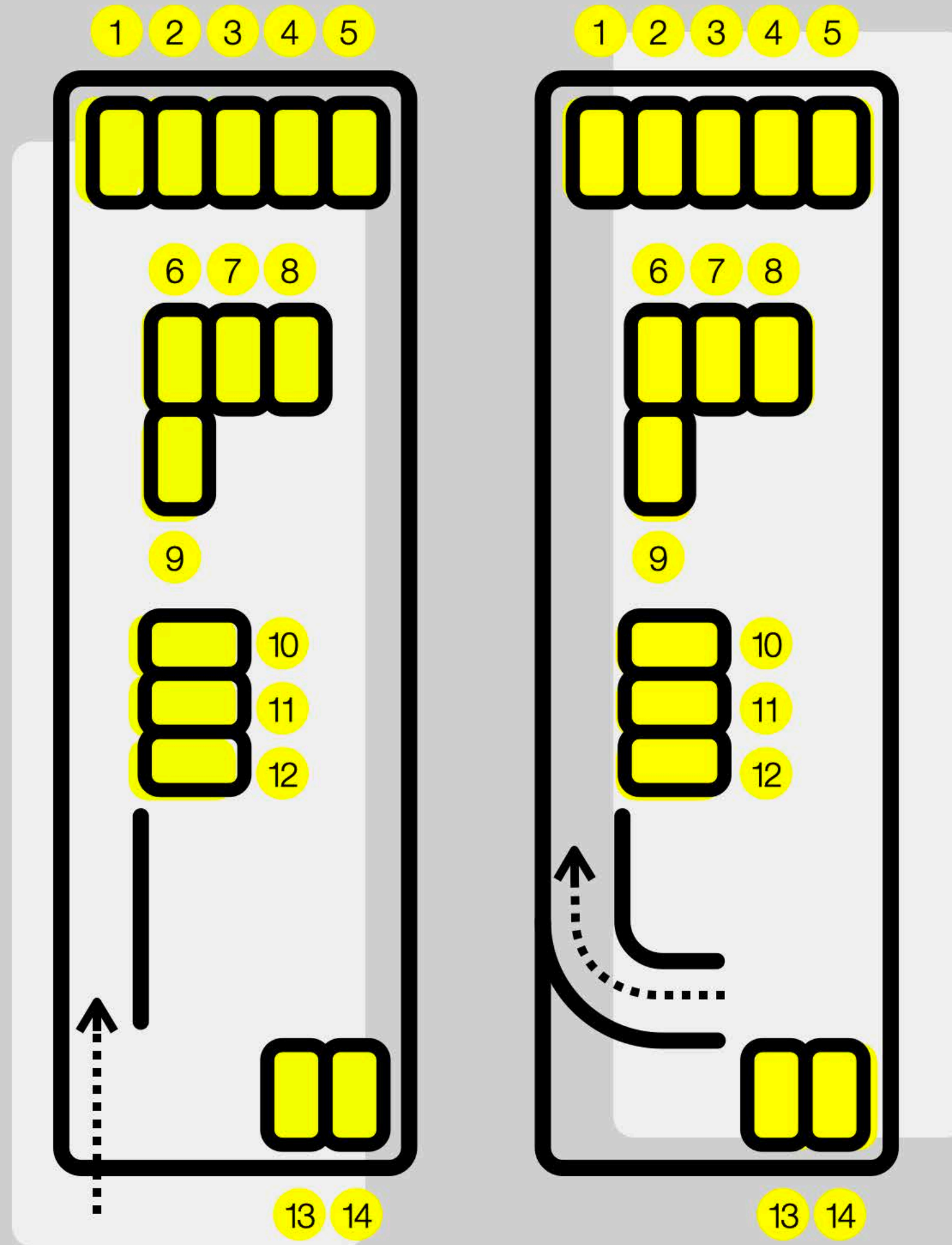
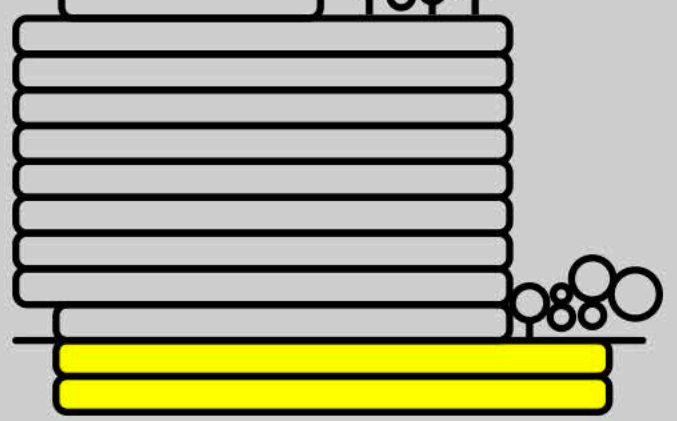
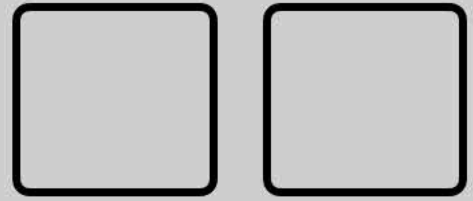
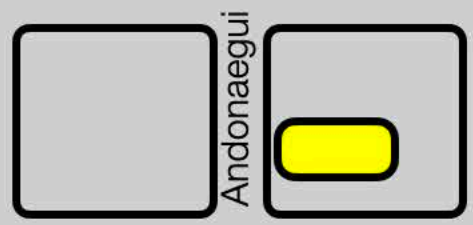

ANDO

Andoraegui 2129
Boulevard Mendoza
Villa Urquiza



ANDO

| Andonaegui 2129 | Villa Urquiza



**Rosbaco
& Partners**[®]
REAL ESTATE



Arquitectos & Asociados

FileniFileniDesign[®]

www.rosbacopartners.com